

# Okanagan-Similkameen Rain Garden Guide Book

A reference guide to  
planning, constructing, planting  
and maintaining a rain garden in  
the semi-arid southwest interior  
of British Columbia, Canada.



planting **semi-arid**

**OKANAGAN** soil filtration drought depth  
landscape PLANTS

climate **run-off rain water**

drainage **GARDEN** trees local  
storm



# Introduction



## RBC

Regional Vice President, Okanagan | Karen Borring-Olsen

As one of the hundreds of RBC employees who live and work in the Okanagan, I know first-hand the water issues our communities are facing. As a financial services company, RBC has a role to play in helping to create an environment where innovative companies and organizations can succeed in addressing the world's water challenges. That's why the RBC Blue Water Project supports projects and initiatives like this Rain Garden Guide Book. We hope to build a shared understanding of the economic and environmental impacts of water and how the rain garden solution can help capture and re-use the precious rain resources in our dry southern interior communities. Congratulations and thank you to the team at the Regional District of Okanagan-Similkameen for bringing this important project to life.



## Regional District of Okanagan-Similkameen

RDOS Chair | Mark Pendergraft

The Regional District of Okanagan-Similkameen covers 10,400 sq. km of the southernmost region of the Okanagan. Living in this semi-arid, ecologically sensitive region, climate instability is forcing us to alter our perception of normal. Local governments, as community leaders, are well suited to be a resource for residents; to encourage adaptation strategies. Together with the OBWB, other regional and local governments in the Okanagan, the RBC through the RBC Blue Water Project Grant has become a valued partner in this process, assisting us to provide opportunities to inform residents through hands on workshops, access to relevant information and to lead by example.



## Okanagan Basin Water Board

Executive Director | Anna Warwick Sears

To Make Water Work in the Okanagan, it takes many techniques, including rain gardens! I'm pleased to see the RDOS take the OBWB's rainwater management guide "Slow it, Spread it, Sink it!" to the next level.



**IMPORTANT NOTE:** National, provincial, and local regulations pertain to many of the subjects presented in this guide. Regulations change, as do the technical methods and standards for environmental protection. Be sure to follow applicable regulations covering private land maintenance and related activities for your area.

# Acknowledgments

When undertaking multiple installation projects and hands on learning opportunities, the devil is always in the details. What seems simple at first, becomes much more complex and challenging when the combination of time, distance, geography, several local governments, agencies, construction crews, and consultants are involved at all stages.

The success of the projects documented in this manual is due to the enthusiasm and willingness to contribute by everyone involved, start to finish. Partnerships and collaboration certainly made the gardens and manual better than the sum of its parts. Acknowledgments cannot convey our deep gratitude to the following:

## Principle Authors:

Zoe Kirk	Regional District of Okanagan-Similkameen Project Lead
Eva Antonijevic	Project Coordinator
Bruce Naka	Technical Consultant
Lindsay Bourque	Research/Technical Consultant

## Funders and Contributors:

Royal Bank of Canada	RBC Blue Water Project Grant Fund
Okanagan Basin Water Board	Anna Warwick Sears   Corinne Jackson
Regional District of Okanagan-Similkameen	Engineering and Public Works
Regional District of North Okanagan	Jennifer Miles
Xerindipity Gardens	Karmen Morgan
Regional District of Central Okanagan	Margaret Bakelaar
City of Penticton	Operations Department
City of Kelowna	Ian Wilson   Elizabeth Balderson
City of Vernon	Kendra Kryzak   Operations Department
Okanagan Xeriscape Association	Gwen Steele
Friends of Summerland Gardens	

## Graphic Design

Lindsay Bourque	Liminal Design
-----------------	----------------

## Editor

Judie Steeves	
---------------	--



# Table of **CONTENTS**

<b>1</b>	THE OKANAGAN BASIN	4
<b>2</b>	THE RAIN GARDEN SOLUTION	8
<b>3</b>	HOW TO CREATE A RAIN GARDEN	12
	PLANNING	14
	CONSTRUCTION	18
	PLANTING	20
	MAINTENANCE	22
<b>4</b>	CASE STUDIES	24
	VERNON	24
	KELOWNA	28
	SUMMERLAND	32
	PENTICTON	36
<b>5</b>	RESOURCES	40

# Okanagan and Similkameen **WATERSHEDS**



■ Key Map: location of watersheds in context of British Columbia



# 1



## The Okanagan BASIN

Mudslides that destroy highways and engulf fish spawning habitat; low stream flows that prevent fish passage; and properties inundated with water in heavy storms will be part of our future in the arid Okanagan Valley. They are some of the extreme weather events we can expect due to climate change, and managing flows of water is one step we can take to prevent disastrous consequences.

One technique for better control of flows is creation of what are termed rain gardens or bioswales to capture heavy runoff and release it slowly into the ground to be filtered before it's released into the aquifer. This rain garden guide will describe and illustrate the use of this technique in the Okanagan Basin, which drains from the height of land around the valley in the north, central and south Okanagan. As well, the Similkameen is an integral part of that drainage.

The basin is a narrow strip, nearly 200 km long, covering 8,000 km<sup>2</sup>. It runs north to south from Armstrong to its southernmost point, Osoyoos on the U.S. border. Along the way, a growing human population is grouped in a series of communities, the largest being Kelowna, with a population of about 123,500 (2016). The Okanagan Basin includes six main lakes: Okanagan, Kalamalka, Wood, Skaha, Vaseux and Osoyoos as well as the benchlands and hillsides along either side that feed water into the mainstem lakes.

### Where does water from the Okanagan Basin go?

Flowing south into Osoyoos Lake, water from the Okanagan Basin crosses the international border and into the U.S. Okanagan Basin water then flows into the Columbia River, past the city of Portland to the Pacific Ocean. Many salmon make the journey both ways every year, south as smolts and north as adults ready to spawn, making this international waterway a vital fish highway.

### State of the basin

Before humans settled in the Okanagan and built cities on the landscape, there were ponderosa pine forests, native sage-dotted grasslands, wetlands and riparian areas.

The valley bottom was undisturbed, capturing runoff so that wetlands and river oxbows could act as filters in rain events and during snow melt.

Today, most rivers and streams are fully allocated to water licenses, adding pressure to groundwater sources. Increasing water license requests, population pressure and climate change underscore the need to improve water management strategies across all sectors.

The Okanagan has the lowest available amount of water per person in Canada. The average resident uses approximately 675 litres of water per day, more than double the Canadian average. The need for rain water capture and re-use techniques could not be more important. Residential, commercial and municipal rain gardens can play a role in helping to slow, spread and sink runoff water back into the thirsty earth, reducing the need for irrigation.

### Okanagan climate

The Okanagan features a mild climate which is much drier than most other areas in Canada. The north end of the valley receives more precipitation and cooler temperatures than the south. Generally, Kelowna is the transition zone between the drier south and the ever-so-slightly wetter north. Native vegetation ranges from cactus and sagebrush in the south, to cedar and hemlock trees in the north.

Okanagan weather and climate is influenced by the Canadian Coast and Cascade mountain ranges. Sometimes, extreme cold troughs slide down from the north end of the valley if conditions are right; the jet stream moving southwards as an arctic cold pressure system moves in from the Alaskan panhandle. The Southern Interior region is classified as Great Basin Biome: shrub-steppe, semi-arid desert, between Oliver and the Canada-US border.

What does that mean? “Shrub-steppe has sufficient moisture to support a cover of perennial grasses. Shrubs are dominant, and perennial grasses fill in the rest. “Grasslands” form the next moistest category,

in B.C. farther north where precipitation is greater and evapo-transpiration less. The B.C. government classifies the Osoyoos region as intermediate, naming it “grassland/shrub-steppe,” which may acknowledge a greater component of grass than is normally found in shrub-steppe.” (John B. Therberge)

### What you should know

Climate change is having an effect across the globe. To date, the Okanagan has been less dramatically affected than many other countries or regions, but it is predicted that this region will continue to see changes in climate. Weather anomalies are already being observed: how precipitation is received and distributed, fluctuating temperatures, and trends toward warmer winters. It is important to note that spring snow melt and runoff peaks are shifting. They are moving back from June to April/May. This means the water is lost as it moves through the basin earlier, leaving the Okanagan drier in the hotter peak season months of July and August. This is becoming the ‘new normal.’

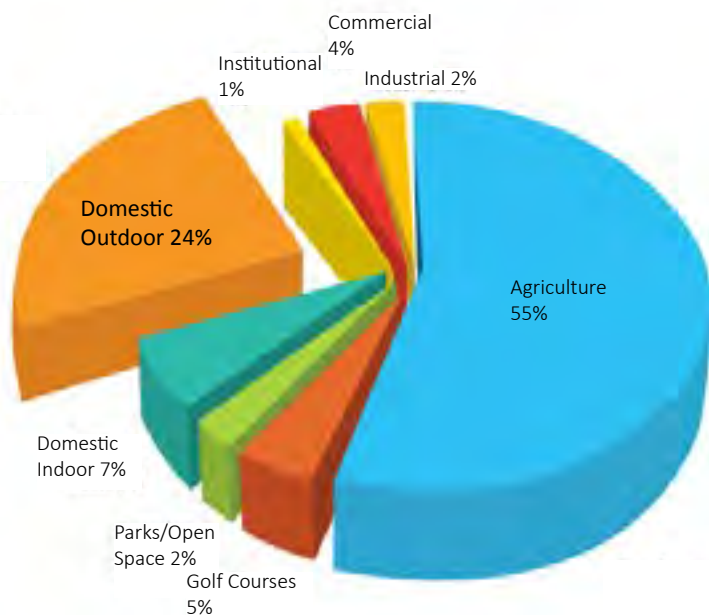

Figure 1: BC Water use by sector. Courtesy of Okanagan Basin Water Board

## Precipitation and rainfall rates in the Okanagan Basin

The graphs shown here provide precipitation and rainfall rates for the Okanagan basin. Metro Vancouver on the south coast of BC has been included in Fig. 2 to illustrate the extreme differences in the amount of moisture received in the Okanagan versus a coastal city.

Precipitation is different than rainfall, as it measures all water transferred from the atmosphere to the surface of the earth including hail, snow, sleet, freezing rain and rain. This explains the discrepancies in the amount shown per month in the charts. Rainfall and precipitation rates are shown in millimetres (mm). There are 25.4 millimetres (mm) to 1 inch.

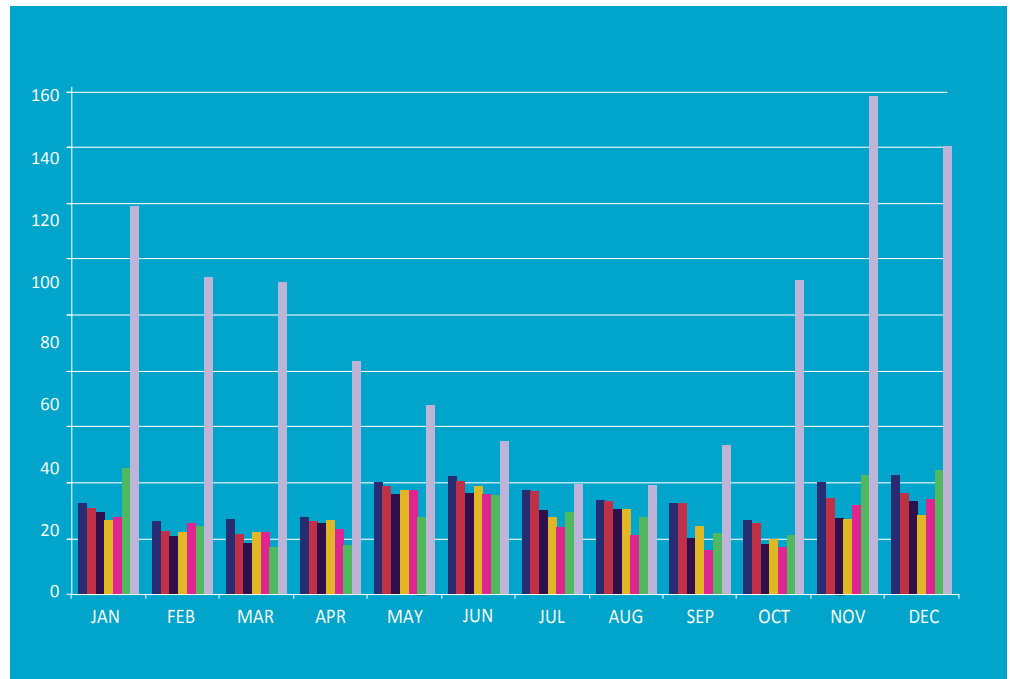

Figure 2: Average monthly rainfall (mm)

■ Vernon   
 ■ Kelowna   
 ■ Penticton   
 ■ Summerland   
 ■ Osoyoos  
■ Princeton   
 ■ Vancouver

Precipitation and rainfall expectations can be correlated with temperature variables, providing a tool for homeowners when making water use decisions. This goes beyond the garden, but includes thinking about water use in and around the home. Temperature variables and precipitation rates are displayed in each of the case studies in chapter 4, at the beginning of each case study.

LOCATION	JAN	FEB	MAR	APR	MAY	JUN	JUL	AUG	SEPT	OCT	NOV	DEC	YEAR
VERNON	6.3	8.5	21.4	27.2	40.1	42.4	37.5	33.8	32.9	24.9	23.5	9.4	308
KELOWNA	7.8	9.6	16.9	25.6	39	40.7	36.9	33.6	32.7	25	21.3	9.1	298
PENTICTON	10.6	13.8	19.1	26.4	37.3	38.9	27.9	30.7	24.7	19.7	27.1	28.4	304.6
SUMMERLAND	8.3	9.9	16.4	25.6	35.9	36.2	30.2	30.5	20.2	17.6	18.9	11.6	279
OSOYOOS	11.9	17.9	20.3	23.4	37.4	35.9	24.3	21.2	16.1	16.8	25.8	17	267.9
PRINCETON	12	7.5	8.5	16.1	27.2	35.6	29.7	27.7	21.8	19.1	23.3	10.8	239.2

Figure 3: Average monthly rainfall (mm)

Environment Canada

LOCATION	JAN	FEB	MAR	APR	MAY	JUN	JUL	AUG	SEPT	OCT	NOV	DEC	YEAR
VERNON	32.8	26.2	26.9	27.7	40.1	42.4	37.5	33.8	32.9	26.6	40.4	42.7	409.9
KELOWNA	30.8	22.6	21.8	26.2	39	40.7	36.9	33.6	32.7	25.5	34.5	36.2	380.5
SUMMERLAND	29.7	20.9	18.6	25.6	35.9	36.2	30.2	30.5	20.2	18	27.5	33.4	326.7
PENTICTON	26.8	22.5	22.3	26.6	37.3	38.9	27.9	30.7	24.7	19.7	27.1	28.4	332.7
OSOYOOS	27.8	25.5	22.5	23.5	37.4	35.9	24.3	21.2	16.1	17.1	32.1	34.2	317.6
PRINCETON	45.3	24.7	17.1	17.8	27.7	35.6	29.7	27.7	21.9	21.4	42.9	44.6	356.3

Figure 4: Average monthly precipitation (mm)

Environment Canada





Arrow-leaved Balsamroot blooming above Okanagan Lake

*Photo courtesy of Okanagan Xeriscape Association*

---

The **OKANAGAN VALLEY** consists of the main **lakes, valley bottom, bench lands** and **surrounding slopes**. Most of us live down on the valley bottom or surrounding bench lands. The valley contains our lakes, agriculture and wineries, tourist facilities and golf courses, industries as well as wetland ecosystems, species at risk and endangered habitat. **With all these competing uses, we need to plan our growth carefully.**

---

### Adjusting to the new normal

With this new normal in mind, how can the Okanagan adjust to both volatile and dramatic rain events alongside periods of drought? Quite simply, “Think like an ecosystem.” By incorporating Low Impact Development (LID) principles in our built landscapes which mimic nature, we can help mitigate the effects of extreme weather events.

LID includes water quality engineering in natural systems to maximize the storage of water for later use, while also designing systems to move and filter it to create a robust storm water management system. Like a lake or beaver pond retention system, LID considers the whole property (site) and looks for opportunities to incorporate:

- Tree coverage: canopy, density or natural materials that provide habitat, water retention in the soil and shade to reduce evaporation
- Natural yard maintenance: less turf, no chemical use, drought-tolerant warm-season grasses
- Native plants: retain and restore (some are ideal for an alternative lawn)
- Green roof technologies
- Permeable paving
- Composting and mulch systems
- Rain water retention systems: rain gardens, cisterns, rain barrels, swales to mitigate storm water runoff

*Note: This manual focusses on rain gardens as a versatile tool for retention, infiltration and reducing/cleansing storm water runoff.*

# 2

## At a glance:

- When the natural environment is altered by human activities, the natural flow of water is severely upset
- Rain gardens mimic nature through the slowing, spreading, and sinking of rainwater back into the ground
- Rain gardens can potentially reduce neighbourhood drainage problems and replenish soil moisture
- Rain gardens provide valuable urban habitat for wildlife and enhance the beauty of neighbourhoods

## The Rain Garden SOLUTION

As rainfall flows over hard impermeable surfaces it collects pollutants such as oil, pesticides, animal feces, household and garden chemicals and grit, becoming what is known as storm water. Polluted runoff water is also a result of washing cars and/or watering lawns. In contrast to sewage, polluted storm water and runoff is not treated and discharges directly 'as is' into our waterways. Polluted runoff negatively impacts the aquatic and shoreline habitat and degrades the water quality of our rivers, streams and lakes.

### Managing storm water

Traditionally, storm water has been managed through the 'just get it away from here' principle. Building gutters and downspouts capture it from roofs and convey it to roadside gutters and storm drains. Road and driveway runoff is also encouraged off the property towards traditional storm drainage systems.

But, there are many better methods that can be employed to manage storm water. Installing green roofs, using permeable surface materials on pathways and driveways, installing rain barrels and cisterns, creating bioswales and rain gardens are all better techniques that 'scrub' this valuable resource. The goal of these management strategies is to slow down the speed of the rainwater runoff, capture it for use later, or allowing it to percolate through the soil and replenish underground aquifers.

The north, central and south local governments of the Okanagan have recently installed a series of public rain gardens to demonstrate how to better manage storm water runoff while simultaneously beautifying landscapes.

This guide book will demonstrate and explain how rain gardens have been created and implemented on four different sites in the cities of Vernon, Kelowna, Summerland and Penticton. These case studies of Okanagan rain gardens illustrate how we can improve

Without **rain gardens**, runoff flows over hard surfaces like **roofs, driveways** and **streets**. It picks up **oil**, and other **pollutants** as it flows into our **waterways, endangering fish and other wildlife.**

the health of our water systems and better deal with overland flooding. Okanagan property owners must take up the challenge of implementing low impact development systems to better manage water on their properties and use storm water instead of directing it off their properties.

### A vital tool for the Okanagan

Rain gardens are a sustainable solution for storm water management, and many are being installed by municipalities and on private properties from coast to coast. A rain garden is a vegetative depression that collects and filters storm water. Rain gardens allow water to temporarily pool, then slowly spread and sink into the earth. Inflowing storm water can be filtered and thus cleaned by plants and soil before re-entering the groundwater system and waterways.

Okanagan property owners are awakening to the need for water-wise landscapes due to our semi-arid climate and droughts. Xeriscape (low water use gardens) and rain gardens seem to be counterintuitive to one another. One may ask where do rain gardens (storm water management systems) fit into the new normal agenda? It's vital we reduce our water use on outdoor landscapes by such tools as designing xeriscapes and rain gardens to help us keep our landscapes alive and beautiful, while using less of our valuable potable water. Figure 1 on page 5 shows the amount of water we use on outdoor landscapes.



Image 1: Conventional storm drain during a storm



Image 2: The outflow of city storm drains.



Image 3: Flooding in Penticton, June 2013. Photo courtesy of Shannon Quesnel –Infotel Multimedia

Lake	Area (km <sup>2</sup> )	Average Annual Evaporation (mm)	Average annual volume lost to evaporation (1996-2006) (ml)	Average annual net inflow (1996-2006) (ML)*
Kalamalka	35.6	905	32,200	34,900
Okanagan	348	918	320,000	609,000
Skaha	20.1	963	19,400	651,000
Vaseux	2.75	1008	2,800	660,000
Osoyoos	15	1068	16,000	696,000

**Figure 1:** Evaporation values are estimated using the Penman-Monteith model. Data courtesy of the Okanagan Basin Water Board.  
\*ML = mega litres = 1 million litres

River	Length (km)	Average Annual Discharge ft. <sup>3</sup> /s (m <sup>3</sup> /s)	MAX Annual Discharge ft. <sup>3</sup> /s (m <sup>3</sup> /s)	MIN Annual Discharge ft. <sup>3</sup> /s (m <sup>3</sup> /s)	Average Annual Net Inflow Acre Feet
Similkameen River	1,967	2,283 (64.6)	45,800 (1300)	65 (1.8)	664,000

**Figure 2:** Net Annual recharge and discharge

(BC River Forecast Centre)

## Understanding Water Volume Units

Calculating water volumes is a complex system of measurement developed over centuries, as is illustrated by the different units of measurement (of mass) shown in these graphs. River volumes are calculated differently than lake volumes because rivers are constantly moving. Therefore, water is passing by and not static. It is difficult to calculate evaporation rates on rivers of any size, unless they are very slow moving bodies of water. Most importantly, these graphs show the 'net inflow' or recharge potential to the water bodies we rely upon in the Okanagan basin.

In lakes, Megalitres (ML) are used to show annual inflows from snow melt into creeks and rivers that recharge the lake. Megalitres are equivalent to 1,000,000 (one million litres) or 35,314 cubic feet. To illustrate sheer volumes, an Olympic sized swimming pool has a capacity of 2.5 ML. The annual recharge into Okanagan Lake is equivalent to 243,600 Olympic-sized swimming pools. Also, recharge volumes increase as you move through the lakes southwards. That is due to water moving from lake system to lake system in the Okanagan Basin, eventually passing over the border, combining with the Similkameen River and flowing into the United States. This shows the interconnection of the basin's water systems and the importance of a coordinated approach; how water is managed in the north of the valley affects everyone downstream.

In contrast, a river recharge or inflow is calculated using acre feet plus the length of the river. As the name suggests, an acre foot is the volume of water required to cover the surface area of a river or land mass to the depth of 1 ft.. An acre is 20.12 m x 201.17 m (66 ft. x 660 ft.) therefore an acre foot is 1,233 m<sup>3</sup> or 43,500 cubic feet. Discharge rates or the volume of water passing a stationary measuring point is calculated using yet a different measurement, cubic metres per second (m<sup>3</sup>). A cubic meter is equivalent to 1,000 litres (264 US gallons) or 6 ½ full bath tubs per second.



Ephemeral pond in the South Okanagan

*Photo courtesy of Dr. Alex Juhasz*

---

**A**n estimated **85%** of **riparian habitats** have been **lost** in the Okanagan-Similkameen **due to development in the valley bottoms**. These areas are now considered **imperiled habitat**, which supports a high number of wildlife species.

---

The Okanagan's arid landscape is continuously in a soil moisture deficit situation, yet its burgeoning population has led to rapid growth in built infrastructure. Development unavoidably impacts hydraulic systems and typically impedes natural processes which water quality depend upon. Interventions that can reduce damage and return the environment to a better balance are desperately needed.

Simultaneously, there is a decline in natural habitat such as wetlands and riparian areas and increasing impermeable surfaces and barriers to flows. We need to understand how development choices impact the viability and health of local riparian habitats, fish and wildlife populations, and community water systems. A 2008 public opinion survey in the South Okanagan showed 79 per cent of residents are concerned with water quality and quantity, loss of habitat to development, and the loss of wildlife. More than a third of those polled think that the environment has suffered in recent years.

It's forecast that climate change will bring warmer winters; longer drier summers; and more frequent extreme weather events. Thoughtful and innovative storm water management is required to help filter runoff and maintain healthy lakes, streams and shorelines.

The four rain gardens illustrated in this guide book will demonstrate how we can create rain gardens suited to our local climate and soil conditions. We set out to solve storm water issues and challenges specific to each site. By closely examining these rain gardens we begin to see how our storm water problems can be artfully resolved.

# 3

**Rain gardens** are created in a depression, either modified or man made, into which excess runoff from hard surfaces such as roofs, driveways, parking lots and sidewalks can pool. They are equipped with plants that tolerate periods of extreme wet and dry conditions at the bottom of the excavation area and more drought-tolerant plants up around the sides. The plants help stabilize the soil and take up some of the water, filtering it before it spreads out and sinks into the ground, recharging the aquifer.

They're an attractive, natural alternative to storm drains, with the added benefit of a natural treatment of water before it's released into waterways. But, they must be designed for the soil types in the area they are created.

## What you need to know:

- Familiarize yourself with local regulations in your area
- Calculate how much impervious surface you will be catching runoff from
- Calculate the volume of runoff
- Design how water will be delivered to your rain garden
- Determine how much sun and shade the garden site receives
- Identify plants that will be suitable for the site

## How to Create a **RAIN GARDEN**

### 01 **PLANNING**



- Determine how much rainfall your site gets. Confirm the location of existing utilities.
- Determine the rainfall collection surface area.
- Evaluate your soil type and test the drainage rate/soil permeability.
- Determine how much water you want your rain garden to hold.
- Determine the ponding depth.
- Identify a safe place to direct the overflow.

### 02 **CONSTRUCTION**



- Lay out the rain garden by using a watering hose, stakes or rope, spray paint or other tools.
- Excavate the soil.
- Create an entry for water (swale, extended rain gutter downspout or pipe).
- Level the excavated bottom of your rain garden but try not to compact the soil.
- Provide a rock-lined overflow.
- Obtain an approved rain garden soil mix or mix compost into your existing soil.
- Place the soil mix into the rain garden and leave space below the overflow for pooling.

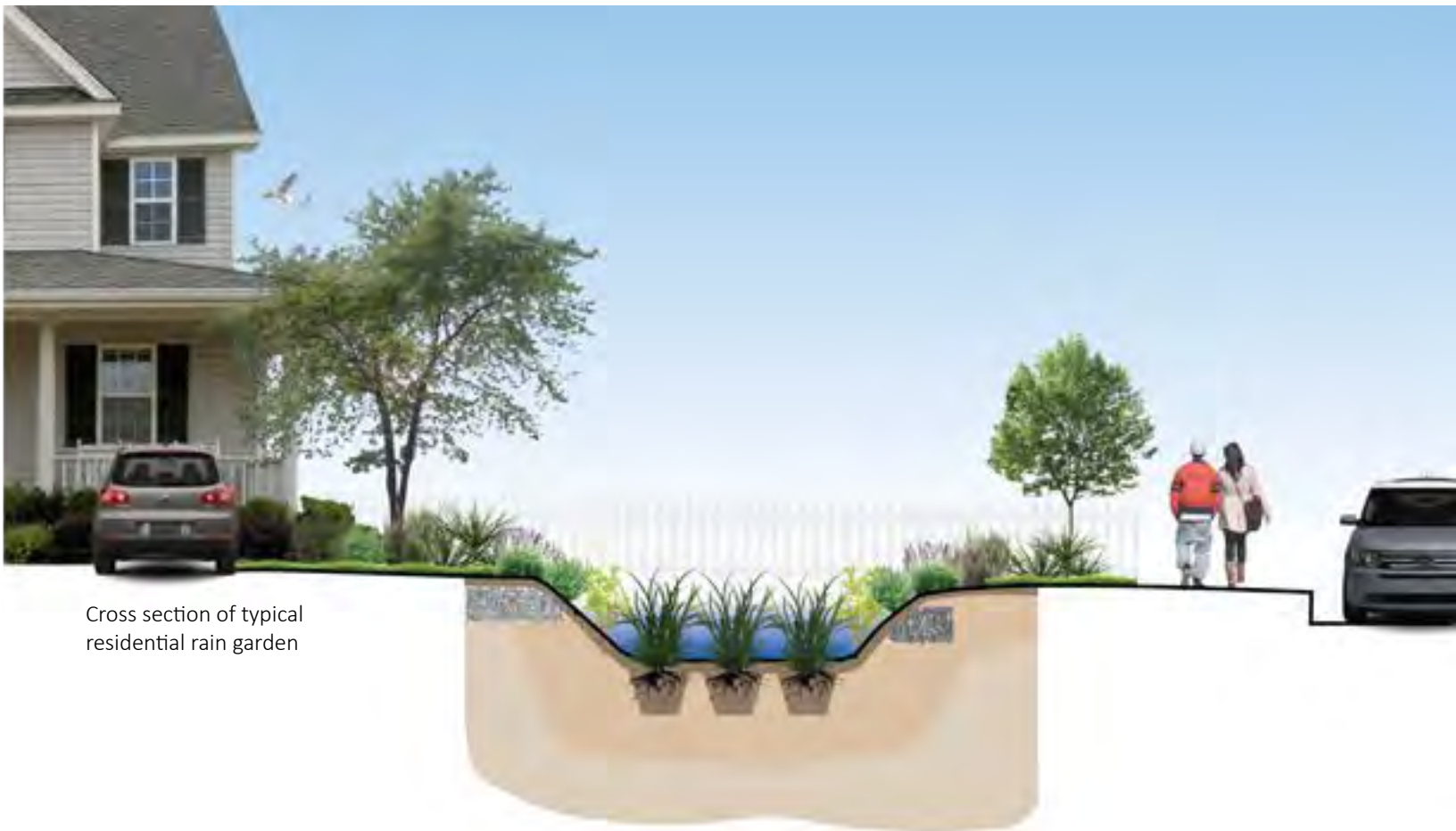

Cross section of typical residential rain garden

## 03 PLANTING



- Select plants for the three planting zones within your rain garden and around the perimeter.
- Use a mixture of evergreen and deciduous small trees, shrubs, ground covers and grasses for year-round interest.
- Cover planted area with mulch to minimize weeds and to hold the moisture.
- Provide water while the plants are getting established.

## 04 MAINTAINING



- Keep inlet and outlet clear of debris and well protected with rock.
- Do not use fertilizers or pesticides.
- Provide water as needed.
- Provide additional mulch as needed.



For a detailed, 96 page construction guide for rain gardens created by Washington State University, click on the Build a Rain Garden tab.

[www.12000raingardens.org](http://www.12000raingardens.org)



# PLANNING

## Choosing the right site:

- Stay at least 3 m or 10 ft. away from the house or foundations
- Ensure the rain garden is gravity fed; either by natural land slope or engineered through piping
- Conduct a 'soil drainage test' as it will inform many other decisions in the development of your rain garden
- Employ an engineer if your yard has more than a 10 per cent slope
- Stay away from septic fields:
  - allow 15 m or 50 ft. uphill, or
  - allow 3 m or 10 ft. downhill from a septic field
- Avoid placing rain gardens within 30 m or 100 ft. of a drinking water well source

The intention behind the **old carpentry adage “measure twice, cut once”** applies to rain garden planning.

A rain garden is a beautiful and functional asset and easy to imagine in your landscape, but creating one requires a significant amount of pre-planning. Planning is the most critical process in the design, construction and future performance of your rain garden. If there are any topographical or difficult challenges to overcome, consulting a landscape architect or designer can be very cost effective. They can help you to avoid expensive problems before they occur and provide advice on details of your plan.

Make several copies of the final design, or use tracing paper over top of the blueprint which makes revisions much easier. Understand the footprint of your home and outbuildings. Look at how structures are situated on your landscape, the topography of the yard and where the major utilities and barriers are located.

Transferring those details to paper is the first step. The checklist provided suggests what you need to consider and how to gather the information. It is important to map on your blueprint all the different variables for where the garden should not be built. This will give you a good idea of the remaining area of the yard that is available for excavation. Stand in the area where a rain garden could be located and evaluate the site. Is it where you envisioned it to be for visual attractiveness?



If it fits your aesthetic ideals, investigate all the potential runoff and catchment areas that will be directed to the rain garden. Look for signs of how water acts on your landscape: regular pooling in the yard, runoff erosion troughs, water line stains on driveways and pathways. These all indicate where water runs in a rain event. Will any of those be mitigated by the rain garden? If so, calculate the volume of runoff from all sources using the charts or links provided.



Image 1: Glacial Till

### How Quickly Does your Site Drain?

Once the prospective location of the garden is determined, the next step is to do a soil drainage test. There are three steps to the soil evaluation test:

**Step 1:** Dig the hole .60 m (2 ft.) deep and .30 m to .60 m (1 ft. to 2 ft.) in diameter (*see page 16*)

**Step 2:** Evaluate the soil texture; see Construction section for texture notes

**Step 3:** Fill the hole with water and observe the drainage rate over time

**Note:** Repeat 3x if it is done during the summer. You may want to dig more than one test hole to compare rates.

Once drainage rates are known, use the rain garden sizing chart and equation to determine the amount of holding capacity required which will give you an idea of the size the garden area will need to be.

Knowing the size needed for the holding pond provides the basis for designing the overall look of the finished site.

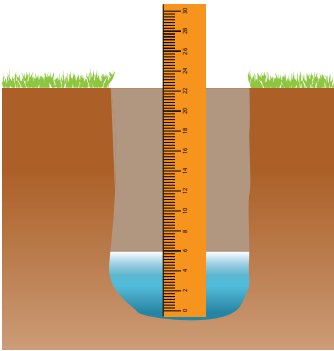

Image 2: Glaciofluvial



Image 3: Soil Drainage Rate- Percolation test

## How to do a soil drainage test:



### Example #1

Fill the hole with 15.25 cm (6 in.) of water.

If the water drains in 12 hours, the drainage or infiltration rate is:

- 15.25 cm (6 in.) divided by 12 hours = 1.27cm or (0.5 in.) per hour.
- Record the drainage rate for later comparison to the rates shown in the rain garden sizing chart (*see next page*)

or

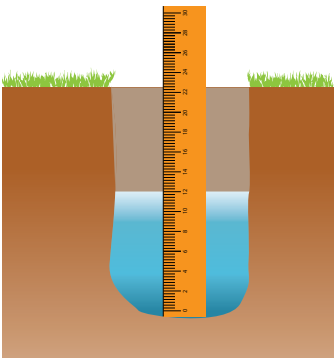

### Example #2

Fill the hole with 30.5 cm (12 in.) of water.

If the water drains in 40 hours, the drainage or infiltration rate is:

- 30.5 cm (12 in.) divided by 40 hours = 2.5 cm (1 in.) per hour
- Record the drainage rate for later comparison to the rates shown in the rain garden sizing chart (*see next page*)

		DRAINAGE RATES			
Ponding Depth		.64 -1.25 cm/hr .25 - .49 in./hr	1.27- 2.5 cm/hr > .5 - .99 in./hr	2.52 - 6.32 cm/hr 1 - 2.49 in./hr	> 6.4 cm/hr > 2.5 in./hr
Good - 85% of runoff captured	6"	7%	7%	6%	6%
	12"	10%	8%	6%	6%
Better - 95% of runoff captured	6"	9%	8%	8%	8%
	12"	14%	11%	9%	9%
Best - nearly all runoff captured	6"	10%	9%	9%	8%
	12"	N/A	9%	8%	8%

Figure 2: Soil drainage rates and quality

### Practical Tips:

- Use a hose, rope or spray paint to measure off the desired rain garden section
- Identify location of gravity inflow and outflow (outflow must be lower than inflow)
- Soil mix for rain garden should be made up of 60% screened sand and 40% compost

### Optional Features:

- Biochar can be used as a soil amendment for more intensified infiltration – useful if rain garden is built close to a parking lot or other more contaminated surfaces from which storm water is collected

## Sample calculation:

A 232.25 m<sup>2</sup> (2500 ft.<sup>2</sup>) catchment area:

- Using the best scenario from the chart opposite:  
1.27 cm (0.5 in.) per hour and 30.5 cm (12 in.) ponding depth using Best = 9%
- Multiply contributing area X sizing per centage to find required surface area for ponding.

$$232.25 \text{ m}^2 \times .09 = (225 \text{ ft.}^2)$$

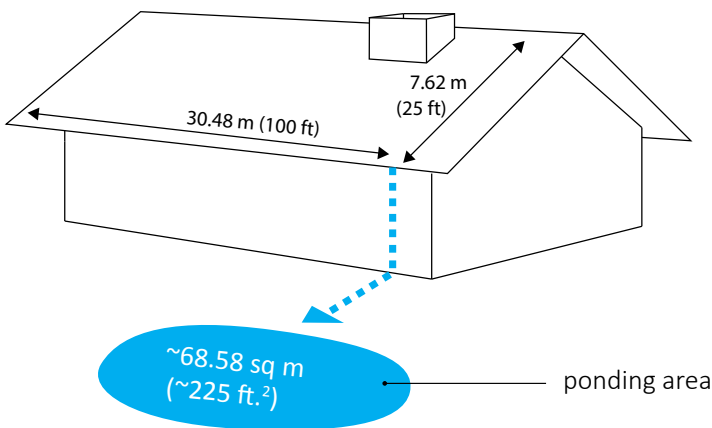
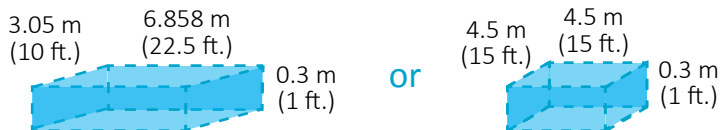

Figure 3: Calculating catchment area (roof) and ponding area

That means 225 ft.<sup>2</sup> of ponding area, for example:



- With the area of ponding determined, add the edge planting zone to calculate the entire area required.

Now, you can design the garden on paper and prepare a garden plan. This may take several attempts to come up with a shape and planting profile that you are happy with and suits your landscape. Once you are happy with your design plan, it's time to lay out the rain garden using garden hoses, eco paint or markers and the construction phase begins.



Image 4: Rain garden placement



Image 5: Rain garden placement



Image 6: Using spray paint to lay out garden area



# CONSTRUCTION

## What you'll need before you dig:

Keep a copy of your rain garden plan handy to make notes to help clarify directions for workers helping on the project.

- Copy of rain garden plan
- First aid kit, safety supplies, protective eyewear (for work crew)
- Measuring tape or stake
- Wood stakes
- Layout tools (e.g: rope, string, ground paint, builder's chalk)
- Hammer/sledge
- Shovels and rakes (picks and hoes if needed)
- Digging bar
- Excavation equipment - mini excavator, sod remover, backhoe
- Tarps (for debris and/or soil)
- Wheel barrow
- Inflow and outflow pads or materials (pipes, rocks, pond liner)
- Rain garden soil or soil amendments (compost, sand)
- Rocks for inflow and outflow and containment area if required
- Hardscape items – if using them in the garden
- Water access

## Constructing Your RAIN GARDEN

Construction of the rain garden can begin once the planning phase is complete. A handy checklist is provided for ensuring the required tools, equipment, labour and materials are all ready. With the excavation plan in hand, lay out the proposed garden with hoses, ropes, or eco-spray paint. Once the shape has been marked out and approved, excavation can begin.

Once the site has been excavated the inflow and outflow can be located. Working back from the inflow point, confirm how the runoff water will flow to the garden; whether it will be gravity-fed overland i.e., in a swale or dry creek bed, or through a piping system. If underground pipes are to be employed, do a test run with a hose into the pipe to make sure it is positioned correctly before burying it. Fig 1. Steeper above-ground inflows may need a check-dam of rocks or other material to slow down the inflow.

Setting a flat rock or concrete pad under the inflow at the edge of the garden will reduce erosion. The outflow should be designed to allow the extra water to access designated runoff areas such as storm drains, or dry wells. To slow outfall water, construct a rock-filled drainage containment area, 15 cm deep (6 in.) and a metre (3 ft.) square. Some rain gardens incorporate a charcoal filter bag at the exit point to further cleanse the water that leaves the garden.

### Option 1: Poor soil

If you are working with a clay soil which doesn't drain, or sandy, gravelly soil that drains too quickly, complete removal of the soil is recommended. Soils that drained over 2.5 cm or 1 in. per hour require a soil amendment that holds moisture. In some cases a base layer of compost or compost/clay is recommended at the bottom of the ponding area. Consider this when calculating ponding depth and adjust accordingly.

Replace the soil with a good ‘rain garden mix’ which is 60 per cent screened sand and 40 per cent compost. Some garden centres or landscape suppliers have their own formulations called rain garden or bio-retention soil mixes. If excavated soil will not be reused at all, check with your local government for disposal options.

### Option 2: Moderate or good soil

If you have moderately good soil with optimal drainage rates, then reusing it is a cost-effective option. The look and feel of your soil will tell you what per centage and type of amendment is required before back-filling the site. It is ideal to use a ratio of 65 per cent original soil to 35 per cent compost. The usual rule of thumb is that 2/3 of the original soil can be reused, leaving 1/3 to be incorporated into a berm or used elsewhere in the landscape.

### Important considerations

It is important to avoid over-compacting the soils in the rain garden excavation area, especially if using excavation equipment. Be sure to rough up the soil in the whole rain garden depression before refilling with fresh soil. Before back-filling the rain garden with soils, install or construct the inflow and test the system using hoses to replicate the runoff coming from the catchment areas. Add water to catchment area downspouts, swales, dry creek beds and trenches, to ensure the water runs into the garden and does not divert and pool or run off creating a problem somewhere else. Check soil depths and levels throughout the refilling process, to make sure the shape and contours of the garden follow your design. After a final raking, you can look forward to planting your rain garden.

### Determining the total depth of your rain garden:

Constructing with no berm:	Constructing with berm:
15 cm (6 in.) outflow, containment area – <i>no berm</i>	15 cm (6 in.) containment area <i>with berm</i>
+ 15 cm (6 in.) ponding depth	+ 30 cm (12 in.) ponding depth
+ 30 cm (12 in.) soil replacement	+ 60 cm (24 in.) soil replacement
= 60 cm (24 in.) excavation depth at base of ponding area	= 105 cm (42 in.) excavation depth at base of ponding area

Figure 1: Excavation equation recommendations for rain gardens



Image 1: Hand Excavation

### Excavating Your Garden

Before digging, determine the depth of excavation necessary to accommodate the ponding depth, soil mix depth, and overflow containment area. Recommended ponding depth is six or 12 inches. Recommended overflow containment depth is six inches minimum. Recommended rain garden soil mix depths are 12 to 24 inches. Examples for determining excavation depth are provided for each of the rain garden soil mix options below. Refer to page 24 for a typical cross section showing rain garden excavation depths.



# PLANTING

- Rain gardens come in many shapes and sizes, formal or natural in appearance
- Use a diversity of plants for year-round interest and easy care
- Follow the “right plant, right place” principle by grouping plants by their water, soil type and light requirements
- Choose native plants whenever possible to increase the food source for pollinators such as bees, butterflies and hummingbirds

The Okanagan Region is a semi-arid zone which enjoys long, hot, dry days and evenings during the growing season; April to October. This can make a difference when planting, especially in full sun with the intensity and long days of heat and sun.

If an area gets more than six hours of direct sun (including mid-day), this should be considered a xeriscape plant zone.

Interior Sun Exposure Chart	
Full Sun	At least six hours of sun, over the midday period
Part-Sun	Areas that receive morning and/or late afternoon sun with shade or filtered light during the mid-day
Shade	Areas that do not get direct sunlight, but may get dappled light from tree canopy, or be in a bright area.
Deep Shade	Areas that receive no direct sunlight

## Preparing to PLANT YOUR RAIN GARDEN

Make sure to have at least a rough plan showing which plant will be planted where. Choose plants that complement the character of your existing landscape. Native plants excel in a rain garden setting, as they have naturally learned to adapt to their environments, survive and thrive with local precipitation amounts. Incorporate a variety of plants, including small trees, shrubs, herbs, sedges and grasses for year-round/seasonal colour and interesting differences in height and texture.

Location and sun exposure of your rain garden will determine what plants will do best. In determining sun exposure, take into account spring and fall seasons too. Daily sun exposure should determine the placement of the right plant in the right location. Remember that you may need to order your plants from the nursery or other sources ahead of time. Be sure to choose a variety of plants for year-round interest and colour. Lay out the plants in the desired pattern, keeping them in containers until they are planted to prevent drying out before they get in the ground. Space trees, shrubs and plants according to their expected mature size to avoid overcrowding. The garden may look a bit sparse at first, but be reassured, it will mature and fill in.

Choose healthy plants and water each well before removing from the pot. Dig each hole twice as wide as the plant container and deep enough to keep the crown of the young plant level with (or slightly below) the existing grade. In this dry climate, fill each hole with water and allow it to drain prior to planting. Once planted, gently fill in the soil around each plant, firmly tamp around the roots to avoid air pockets and water again.

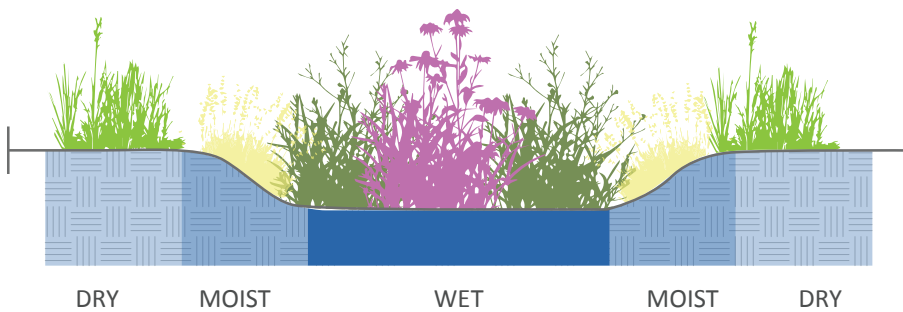
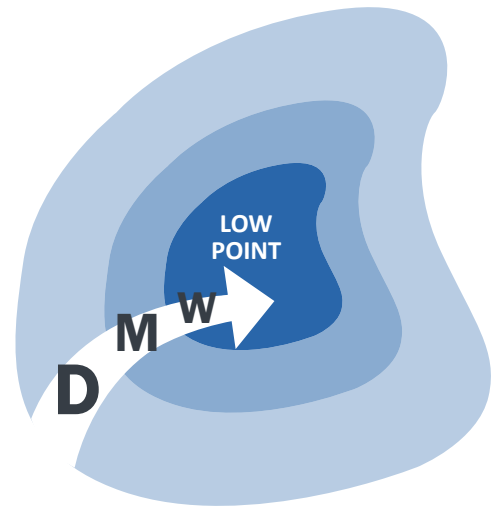

Figure 1: Planting Zones



When you match the **right plants** to the **right place**, your plants grow **stronger** roots, are **healthier**, require less water, reduce or eliminate the need for pesticides and are **more resistant** to pests and disease.

These few steps help reduce transplant shock. The final step in the planting process is to apply mulch evenly over the whole rain garden bed approximately 5 cm (2 in.) thick. Avoid burying the crowns of the new transplants. Leave a small well around each plant.

Water immediately after planting and continue to water regularly (unless it rains) until the plants are established. Once the plants are established (one to two years) you should not have to water your rain garden, unless extreme drought occurs. Plants can be planted anytime during the growing season as long as they get adequate water. Carefully choose plants with their mature size in mind. A mixture of heights adds visual balance and interest. Rain garden soil mixes provide an excellent growing medium, so most plants reach mature sizes more quickly.

## PLANTING ZONES

In a natural setting, plants have adapted to regional climate and growing conditions. Rain gardens have three separate zones to consider: wet, moist and dry. Plant choices will depend on the conditions in each of the zones.

The centre or wet zone will collect and retain moisture. The plants chosen for this area should be able to withstand wet and dry conditions. The moist or mid zone is above the wet zone, created along the sides of the garden ponding area. This area will stay moister as it wicks water from the ponding area of the rain garden.

The dry zone is located on the uppermost, outside edges of the rain garden. This zone functions as a xeriscape garden. It can be nearly flat, slightly convex or a berm. A berm is created by a raised area of soil and in this context prevents storm water from exiting the garden.



# MAINTAINING

## Landscaping guidelines and suggestions

- **Native plants are already adapted to the region and will use less water and require less maintenance once established**
- **Dig out or pull weeds before they go to seed**
- **Apply mulch after planting as required to reduce weeds and keep moisture in the soil**
- **Clean up debris and check for sediment build-up in the inflow and outflow to insure optimum performance of the garden**

## Maintaining your **RAIN GARDEN**

Trimming and pruning excess vegetation will occasionally be necessary. It is important to know your trees, shrubs and vegetation, and prune accordingly. Removing excess plant material by thinning or dividing helps keep the garden looking and performing to expectations. When mowing near rain gardens, either use a mulching blade, or point the mower's grass chute away from the rain garden. Fresh grass clippings are high in nitrogen and should not be applied to rain gardens because they will compromise the effectiveness and performance of the garden. As with a regular garden, your rain garden may require more frequent weeding and watering during the first few years, until the plants become fully established. Regular watering is most critical during the first few weeks after planting. In the Okanagan, it is very important to monitor the garden planting zones during hot, dry spells in the first two years after planting to ensure plants are receiving adequate water.

After the first two years, once plants are established, watering should only be necessary during drought conditions. When watering (or irrigating), water deeply, ensuring that water reaches below the mulch layer and into the soil around the plants. To conserve water, reduce the potential for immediate evaporation, disease and fungal infestation, and improve the potential for infiltration, watering should be performed before 9 a.m. in the morning, and care should be taken not to over water. Rain gardens are designed to absorb excess nutrients, and function as an ecosystem. Plants rarely need fertilizing if the mulch layers and organic materials are replenished over time. If fertilization is necessary, only organic fertilizers should be used.



Schedule	Activity
As needed (following construction)	<ul style="list-style-type: none"> <li>Water to promote plant growth and survival, especially during the first two years and during dry spells</li> <li>Inspect site following rainfall events. Add/replace vegetation in any eroded areas</li> </ul>
Regularly (monthly)	<ul style="list-style-type: none"> <li>Prune and weed swale to maintain appearance</li> <li>Remove accumulated trash and debris</li> <li>Replace mulch as needed</li> </ul>
Annually (semi-annually during first year)	<ul style="list-style-type: none"> <li>Inspect and remove sediment accumulation from inflow</li> <li>Inspect site for erosion. Add/replace vegetation in any eroded areas</li> <li>Inspect rain garden for dead or dying vegetation. Replace vegetation as needed</li> </ul>
Every 2 to 3 Years	<ul style="list-style-type: none"> <li>Replace mulch</li> </ul>

Figure 1 : Rain garden maintenance schedule

Trees, shrubs and herbaceous plants should be monitored regularly for pests and disease. It is important to keep in mind that insect and soil microorganisms perform a vital role in maintaining soil structure. Therefore, the use of pesticides should be avoided so as not to harm beneficial organisms. An alternative to pesticide use is to adopt an Integrated Pest Management (IPM) approach. This involves reducing pests to acceptable levels using a combination of biological, physical, mechanical, cultural, and biochemical controls. Even when ideal conditions exist, a plant may need to be replaced from time to time. If replacing a plant, put the new plant in the same or as near to the old location as possible. The best time to plant is in early to mid-fall or early to mid-spring. Trim established plants as needed to make sure they don't shade out new plantings.

### Infiltration maintenance

Rain gardens are designed to allow for standing water to pond for up to a maximum of 72 hours at a time. Any significant deviation from this may point to drainage issues. Runoff flowing into rain gardens may carry debris, which should be removed regularly to ensure that inflows do not become blocked. When appropriate, curb cuts in parking areas will need to

periodically be cleared of accumulated sediment and debris. Rain gardens should receive a protective layer of mulch, similar to that provided by leaf litter in a natural forest. Mulch has many benefits including the control of weeds, prevention and reduction of soil compaction, provision of nutrients as it decomposes, and conservation of soil moisture. Mulch layers should not exceed two to three inches in depth around trees, shrubs, and avoid mounding around the crowns of perennials. Avoid blocking inflow entrance points and outflows with mounded mulch or raised plantings. The following materials should **NOT** be used as mulch in rain gardens:

- ⊘ Fresh grass clippings
- ⊘ Animal waste
- ⊘ Immature compost
- ⊘ Mulch made from trees such as Cedar, Black Walnut or conventionally raised fruit trees that have been sprayed with pesticides

Always clean up pet waste from your lawn and rain garden to reduce this source of pollution. Studies show that pet waste is a leading source of disease, causing harmful bacteria to end up in our waterways, making them unsafe for human recreational use.

# 4

Typical Temperature Variations:

Summer HIGH: 38.5 C

Winter LOW: -6.7 C

Summerland

Penticton

Osoyoos

Kelowna

Vernon

Annual Precipitation (mm)

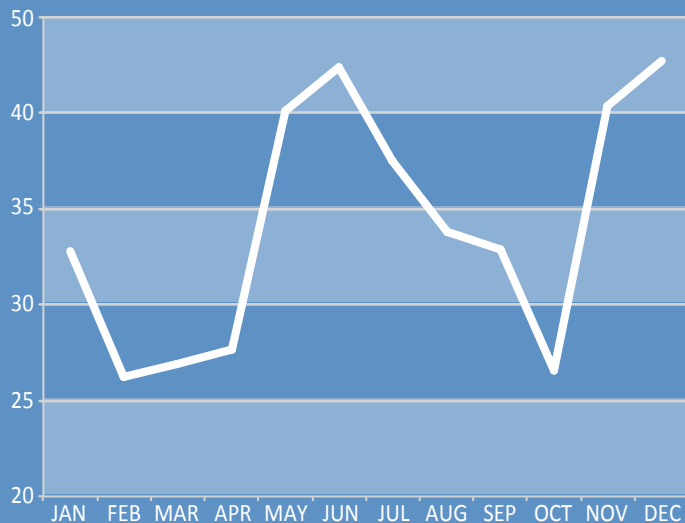

## Okanagan CASE STUDIES

Case Study #1

### VERNON: Xerindipity Gardens

2704 HWY 6

Polson Park, Vernon, BC

Xerindipity Garden was chosen based on its central location in Polson Park. It is a hub of educational outreach programming and is next to downtown Vernon. The rain garden project was seen as a beneficial addition to the xeriscape demonstration garden, as there were drainage issues in the area adjacent to the existing garden and the neighbouring building, Heritage Hall, which had gutter and runoff problems. The rain garden addresses runoff from a portion of the hall roof that would otherwise pool and block a paved pathway.

The rain garden was designed by Dusty Shovel Gardens, a local landscape contractor with expertise in rain gardens and xeriscape projects. The City of Vernon provided additional support in setting up the rain water diversion from the Heritage Hall roof. Staff from the Regional District of North Okanagan manage the Xerindipity Garden and will be including the rain garden in sustainable landscaping programs for the public, which include interpretive signs and workshops.

The size of the rain garden was calculated using the formula seen on page 17. The amount of runoff water was calculated using the square footage of the most accessible portion of the Heritage Hall roof (56 m<sup>2</sup> or 600 ft.<sup>2</sup>). Runoff from other sections of the roof is collected in an existing rain barrel water harvesting system. Based on that runoff area, it was determined that the rain garden needed to absorb a possible maximum rain event of 3 cm (1.25 in.) which would require a garden sized to 30 per cent of the catchment area (180 ft.<sup>2</sup>). The actual rain garden size was set at approximately 19 m<sup>2</sup> (200 ft.<sup>2</sup>) to provide some additional absorption capacity. The shape of the garden was designed with consideration of several factors, including the available

space, the already-existing hardscapes, public accessibility and the need for wide pathways, maintenance access to the gate, 'tying in' a dry river bed component, and aesthetic appeal (Image 1 and 4).

The construction began with the Heritage Hall; the gutters were adjusted to deliver water to the new rain garden bed. Next, the dry river bed was dug out. The runoff pipe from the downspout at the Heritage Hall was dug in under the dry river bed (along the wrought iron fence). Once the runoff and inflow piping was installed, the pond area was excavated. A few feet into the rain garden, the inflow pipe transitioned to a larger perforated pipe in the base of the ponding area in order to distribute the water more evenly within the garden and to avoid erosion. An overflow box, called a dry well, was installed at the bottom edge of the rain garden to deal with the possibility of high volume rain events, which might produce more water than the garden is able to absorb.

The ponding areas were refilled with a mix of approximately 1:1 sand and topsoil/composted manure. It took 8 yards of new material to prepare the rain garden beds. This included about 0.8 m<sup>3</sup> or 1 cu. yard of biochar<sup>1</sup>, a moisture holding material mixed throughout. The soils were put deepest in the bowl, and gradually less so as the garden moves towards extremely drought tolerant plants along the edges. Scarifying the depression (loosening and scratching up the existing soils) when mixing in the first few inches (or centimeters) of new soils helps to blend the two different mediums together, so there is no break from one type of soil to another.

Several principles and considerations<sup>2</sup> factored into the selection of the plant palette. In addition to the water requirements of the plants, it was also important to choose plants that would provide season-long interest and a variety of colours and textures. Also important were plants that increase the habitat value of the garden. Finally, choosing plants that complemented those already found in the adjacent, per-existing beds provided a cohesive balance.



Image 1: Existing conditions on site prior to installation

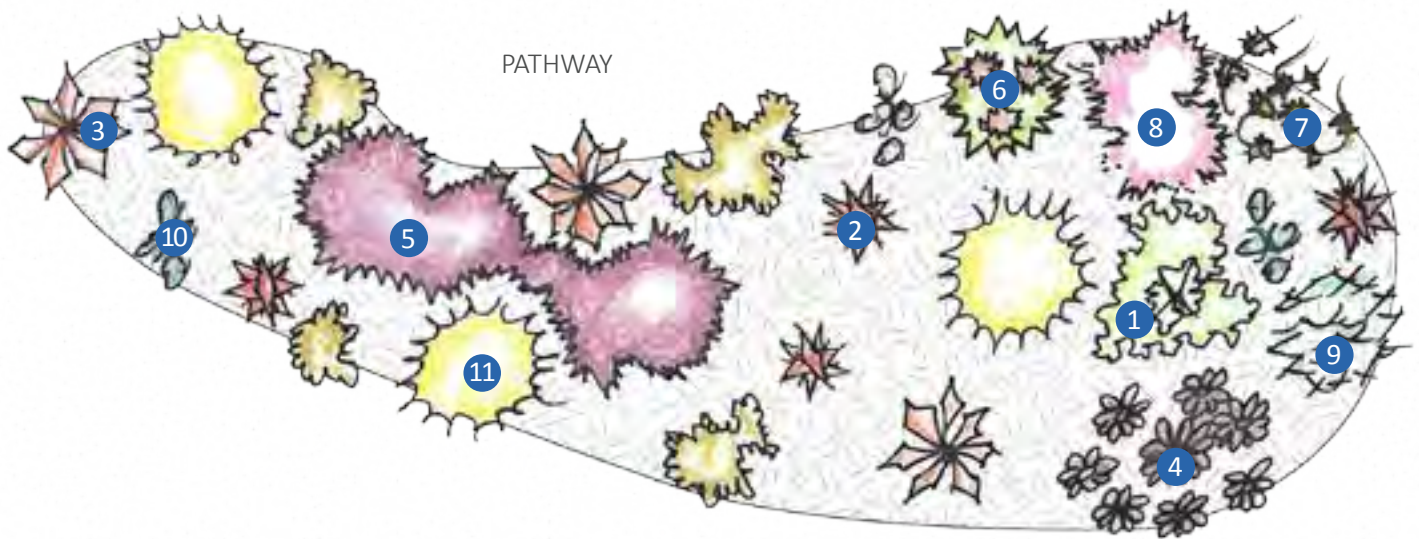

Image 2: After site rehabilitation and rain garden installation



Image 3: Rain garden in bloom

# Xerendipity Rain Garden: Planting Plan



Bruce Naka, of Sound Water Advice, installed the water pipe under the dry river bed to direct the roof runoff into the rain garden while Bob Fleming, of Earth Effects Landscaping, installed a drip irrigation system to help the new plantings get established and to be used in future years during long periods of extreme drought. The irrigation system proved critical in year one, as construction started after a dry spring followed by higher than normal temperatures along with only one major rain event in July and much lower than average rain in August.

<sup>1</sup> Biochar is a natural material made from wood that is burned in a high compression temperature kiln. This makes a form of charcoal a purification material. The difference between biochar and regular char is the moisture holding capacity of the biochar. It provides two functions; moisture holding and water purification. Biochar can be used to filter inflow and outflow water as a purification material but, the addition of this material throughout the planting medium is experimental. It will be monitored for performance over the next few years.

<sup>2</sup> An on-going challenge of this site is the presence of a Siberian Elm adjacent to the garden, which results in large numbers of seedlings throughout the growing season.

## Plant List

### SHRUBS

- |   |   |
|---|---|
| 1 | <i>Euonymus alatus</i> 'Compactus' (Burning Bush) |
|---|---|

### PERENNIALS

- |    |  |
|----|--|
| 2  | <i>Aquilegia</i> spp. (Columbine)                    |
| 3  | <i>Hemerocallis</i> spp. (Daylily)                   |
| 4  | <i>Echinacea</i> spp. (Coneflower)                   |
| 5  | <i>Liatris</i> spp. (Gayfeather)                     |
| 6  | <i>Sedum</i> spp. (Stonecrop)                        |
| 7  | <i>Sempervivum</i> spp. (Hens and Chicks)            |
| 8  | <i>Coreopsis verticillata</i> (Threadleaf Coreopsis) |
| 9  | <i>Artemisia schmidtiana</i> (Silver Mound)          |
| 10 | <i>Anemone patens</i> (Prairie Crocus)               |

### GRASSES

- |    |  |
|----|--|
| 11 | <i>Calamagrostis x acutiflora</i> 'Karl Foerster'<br>(Feather d Grass) |
|----|--|



Image 4: Existing conditions on site prior to installation



Image 5: Rain gardens after installation



Image 6: Dry river after installation

Typical Temperature Variations:

Summer HIGH: 39.5 C  
Winter LOW: -7.4 C

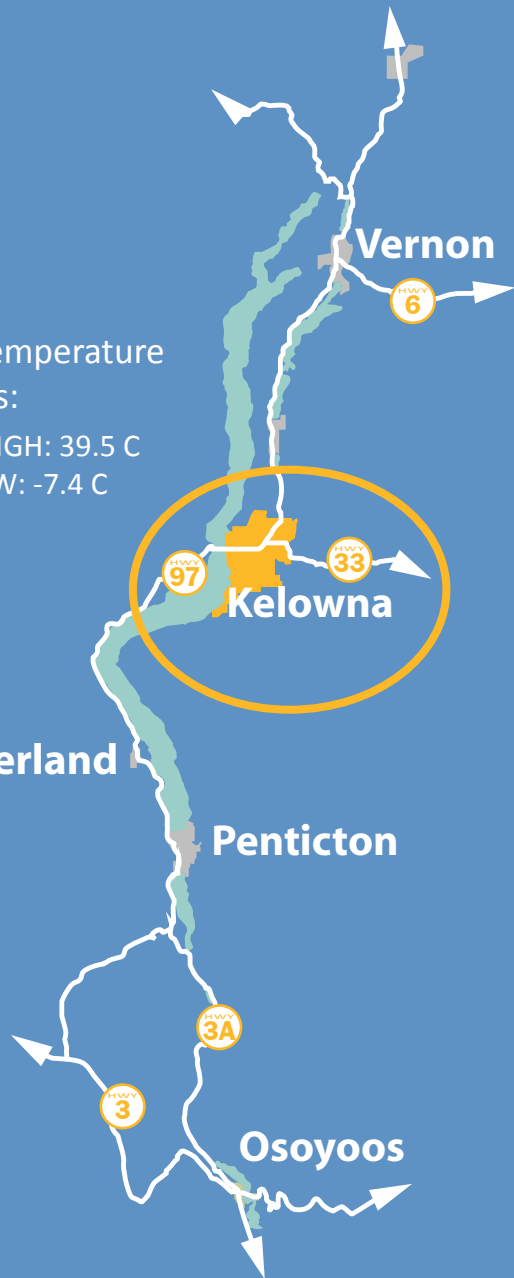

Annual Precipitation (mm)

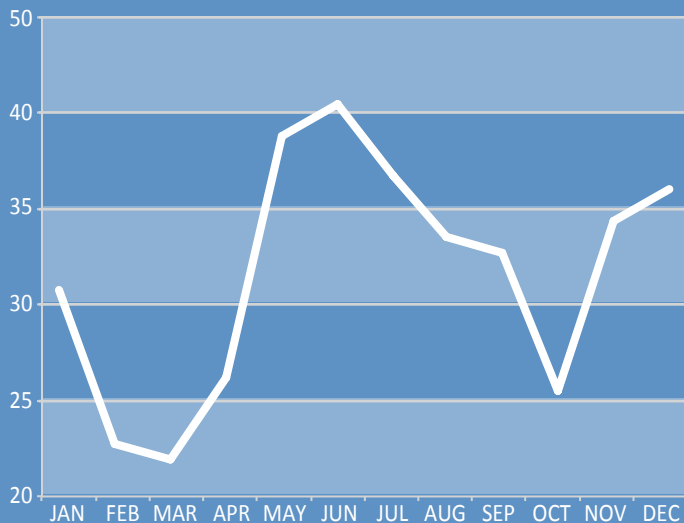

Case Study #2

## KELOWNA: Street-level bioswale

Lakeshore Road between Cook Road and Truswell Road

The City of Kelowna’s 2009 Linear Parks Master Plan provides long-term direction for the planning and construction of a well-coordinated, sustainable and environmentally-responsible trail network spanning the entire city, as well as providing recreational opportunities and accommodating alternative transportation for a diverse range of trail users.

During construction of a multi-use pathway along Lakeshore Road near Mission Creek, as part of this plan, it was decided that a rain garden accessed by a curb-cut would be beneficial to capture road and pathway runoff.

Rain gardens designed with a curb-cut can be effective in capturing storm water from streets, parking lots, and other paved areas. A curb-cut is the term used to describe a break or section removed from a continuous curb at the road edge to allow for water runoff to be directed off the road surface to avoid pooling. In addition to reducing storm water volume, curb-cut rain gardens enhance urban aesthetics, reduce pollutant concentrations, and help counter-act urban heat. A sample curb-cut rain garden planting plan is included on pages 30-31 of this guide book. Below are some things to consider when designing a curb-cut rain garden:

- **Plant height:** When planting in a streetscape, be sure to consider sight lines, particularly when planting in medians and conflicts with overhead utilities.
- **Salt tolerance:** Plants in a curb-cut rain garden must be able to tolerate the road salt that accumulates in the soil and on exposed trunks and branches in the winter months. See the enclosed plant list for salt-tolerant plants.
- **Right-of-way:** Anyone wishing to work within the right-of-way must obtain permission from the local municipality. A permit may be required.

**Pretreatment:**

To prevent clogging due to excess sediment it is best to pretreat the storm water before it enters the curb-cut rain garden if storm water runoff is collected from a road or parking lot.

The curb-cut must be done by a licensed contractor after obtaining a permit from the municipality. Such permit requests should be accompanied with all the information regarding the rain garden. Things to be supplied for review include size of garden, proximity to the drip line of boulevard trees, slopes, and other criteria related to public safety concerns.

Existing dirt should be excavated to a depth of approximately 96 cm (18 in.) below the curb elevation and a soil mixture of topsoil and compost should be brought in. The contractor/homeowner will also need to apply a layer of mulch for erosion control.

Curb cut of inflow bioswale systems like this example, can be done on a smaller scale as a solution to driveways with runoff issues.



Image 1: Inflow and beehive catch basin



Image 2: Inflow detail showing rip rap splash pad to help prevent erosion

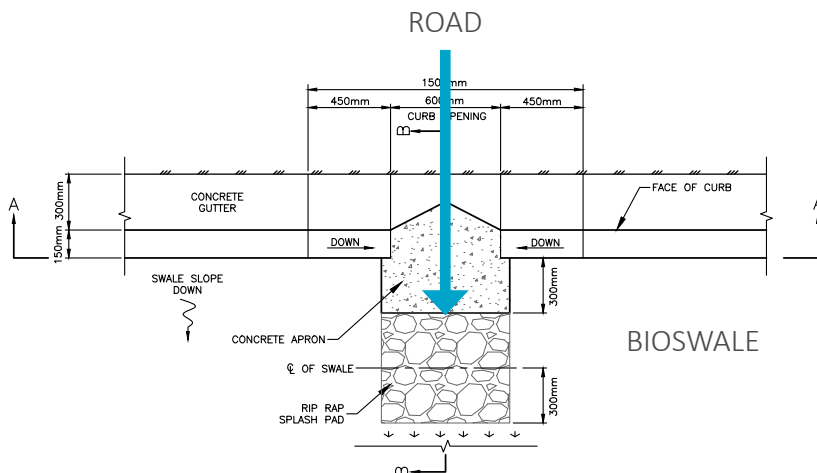

Figure 1: Plan detail of inflow (courtesy of City of Kelowna)

# Kelowna Curb Cut Bioswale: Cross Section Detail

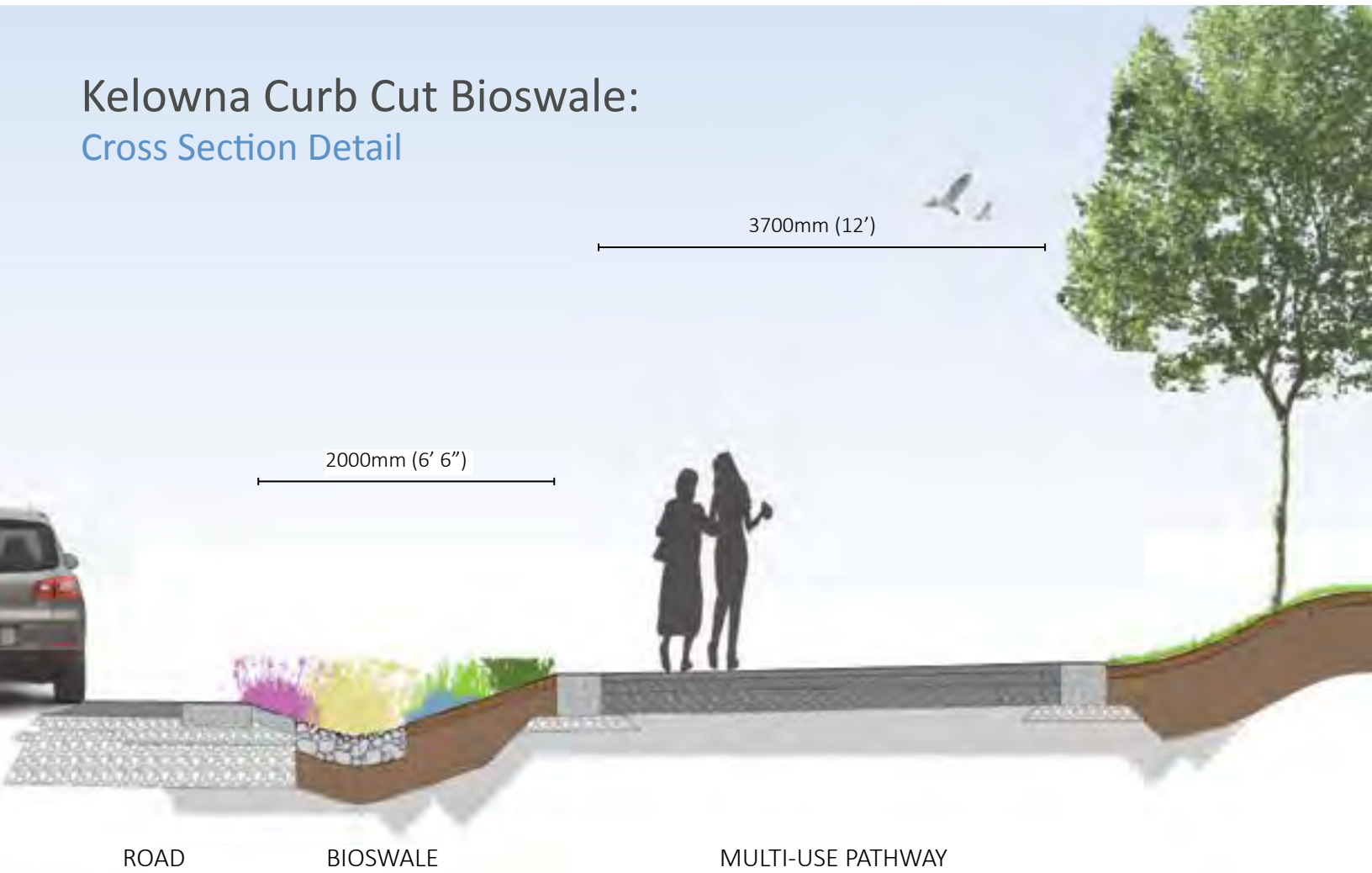

Figure 2: Section showing Bioswale

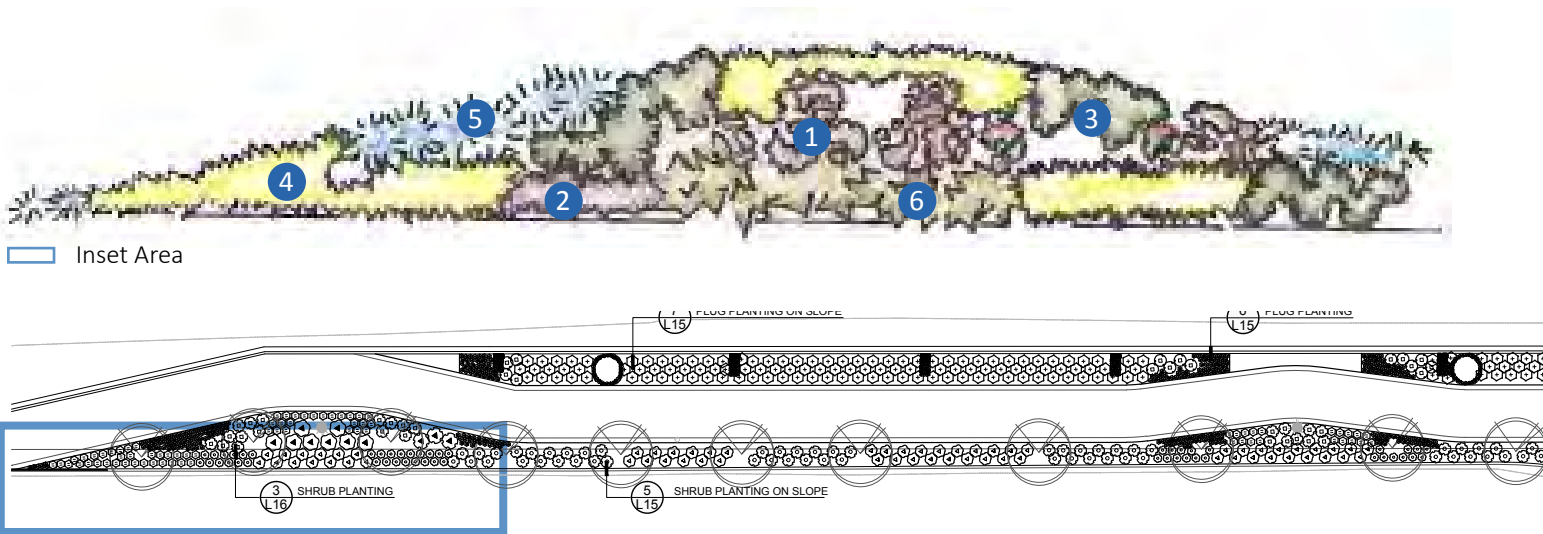

Figure 3: Planting Plan (courtesy of the City of Kelowna) and Planting Detail



# Plant List

SHRUBS	
1	<i>Euonymus alatus</i> 'Compactus' (Burning Bush)
2	<i>Lavandula angustifolia</i> (English Lavender)
3	<i>Perovskia atriplicifolia</i> (Russian Sage)
	<i>Pinus mugo var. pumilo</i> (Dwarf Mountain Pine)
	<i>Potentilla fruticosa</i> 'Goldfinger' (Cinquefoil)
	<i>Spirea x bumalda</i> 'Anthony Waterer' (Meadowsweet)
PERENNIALS	
	<i>Artemisia schmidtiana</i> 'Nana' (Silver Mound)
4	<i>Coreopsis</i> x 'Tequila Sunrise' (Variegated Tickseed)
	<i>Echinacea purpurea</i> (Purple Coneflower)
GRASSES	
	<i>Deschampsia cespitosa</i> (Tufted Hair Grass)
	<i>Elymus cinereus</i> (Giant Wild Rye)
	<i>Festuca arizonica</i> (Arizona Fescue)
5	<i>Festuca glauca</i> 'Elijah Blue' (Blue Fescue)
	<i>Helictotrichon sempervirens</i> (Blue Oat Grass)
	<i>Pennisetum alopecuroides</i> 'Little Bunny' (Fountain Grass)
6	<i>Schizachyrium scoparium</i> (Little Bluestem Grass)



Image 3: Idaho fescue and potentilla are tough plants suitable for roadside planting



Image 4: Newly planted boulevard



Image 5: Planting boulevard

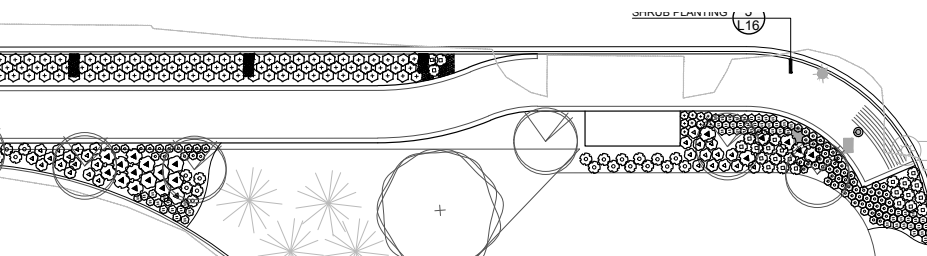

Typical Temperature Variations:

Summer HIGH: 38 C  
Winter LOW: -5.2 C



Annual Precipitation (mm)

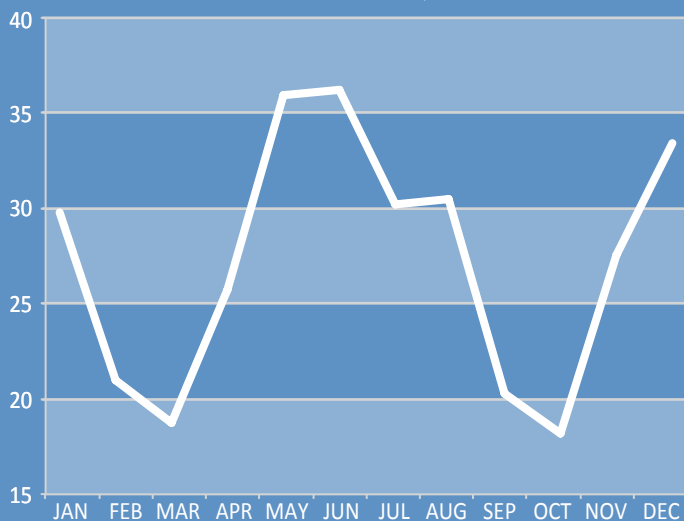

### Case Study #3

## SUMMERLAND:

### Summerland Ornamental Gardens

4200 HWY 97  
Summerland, BC

As a part of ongoing water conservation initiatives at the Summerland Ornamental Gardens, the Friends of Summerland Ornamental Gardens, in collaboration with the Summerland Research and Development Centre, made a decision in 2013 to prioritize a storm water problem on the property. During rain events storm water would rush from the gutterless gazebo roof and run down the inclining asphalt surfaces, gouging out the gravelled service road. It was decided the best solution to this problem would be to install a rain garden to capture these storm water flows (Image 1).

With funding from the Royal Bank Blue Water Community Action Grant and a Real Estate Foundation of B.C. grant we were able to begin our project. Volunteer landscape architects Donna Lane and Lindsay Bourque (B. C. Society of Landscape Architects intern) began site analysis in the fall of 2013 by determining the soil texture and soil drainage rates at the site. Additionally they calculated the catchment area, or how much surface area would drain into the rain garden (Figure 1). Further analysis required estimates of how much rainfall the chosen location would receive, (see sample calculation on page 17), how much water we needed the rain garden to hold and an assessment of the size our rain garden needed to be. There was no limit on the size of the site area, so we could create a robust rain garden that would allow for any "one-in-100-year" storm event.

After the design was completed, site work began. Using a backhoe, the rain garden construction began and soil was excavated 46 cm (18 in.) on the edges of the garden to 46 cm (30 in.) at the centre of the selected area.

During **rain events** **storm water** would rush from the **gutterless gazebo** roof and **run down** the inclining asphalt surfaces, **GOUGING OUT** the gravelled service road.

At this stage our landscape architects conducted a presentation and demonstration of 'How to Build a Rain Garden' for our members and volunteers (Image 2). The entrance for the inflow was created at the top of the garden (Image 3). A dry gravel bed was installed at the centre of this rain garden and large rocks were placed in selected areas (Image 4). The rain garden was planted with native plants by volunteers (Image 5). After plants were installed, mulch was distributed. Interpretive signage was installed and regular rain garden tours are given to the local community and tourists (Image 6).



Image 1: Storm water runoff

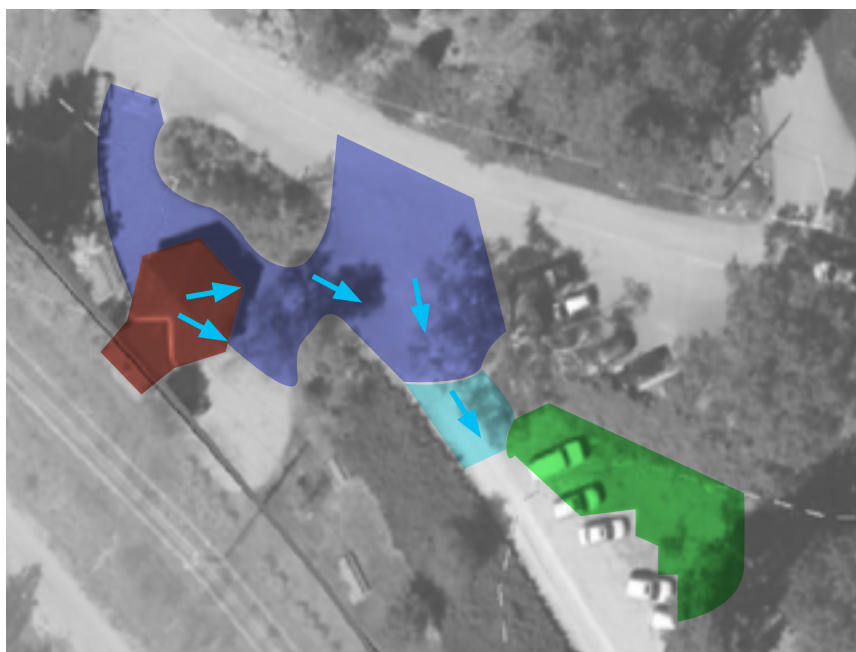

Figure 1: Calculation of runoff surfaces and mapping water flow

## SIZING THE RAIN GARDEN

The Rain Garden Area Calculation =  
min. 20% of total catchment area

Catchment Area calculation:

- Roof of Gazebo area: 100 m<sup>2</sup> (1,075 ft.<sup>2</sup>)
  - Impervious surface: 270 m<sup>2</sup> (2,917 ft.<sup>2</sup>)
  - Permeable gravel road surface: 33 m<sup>2</sup> (353 ft.<sup>2</sup>)
  - Catchment area: 404 m<sup>2</sup> (4,348 ft.<sup>2</sup>)
- min. rain garden size = 80 m<sup>2</sup> (870ft.<sup>2</sup>)

➔ Direction of water flow

Average slope 3%

**Rain Garden Size: 150 m<sup>2</sup> (1600 ft.<sup>2</sup>)**

# Summerland Rain Garden: Planting Plan



Image 2: Explaining design process to workshop participants



Image 3: Inflow of rain garden

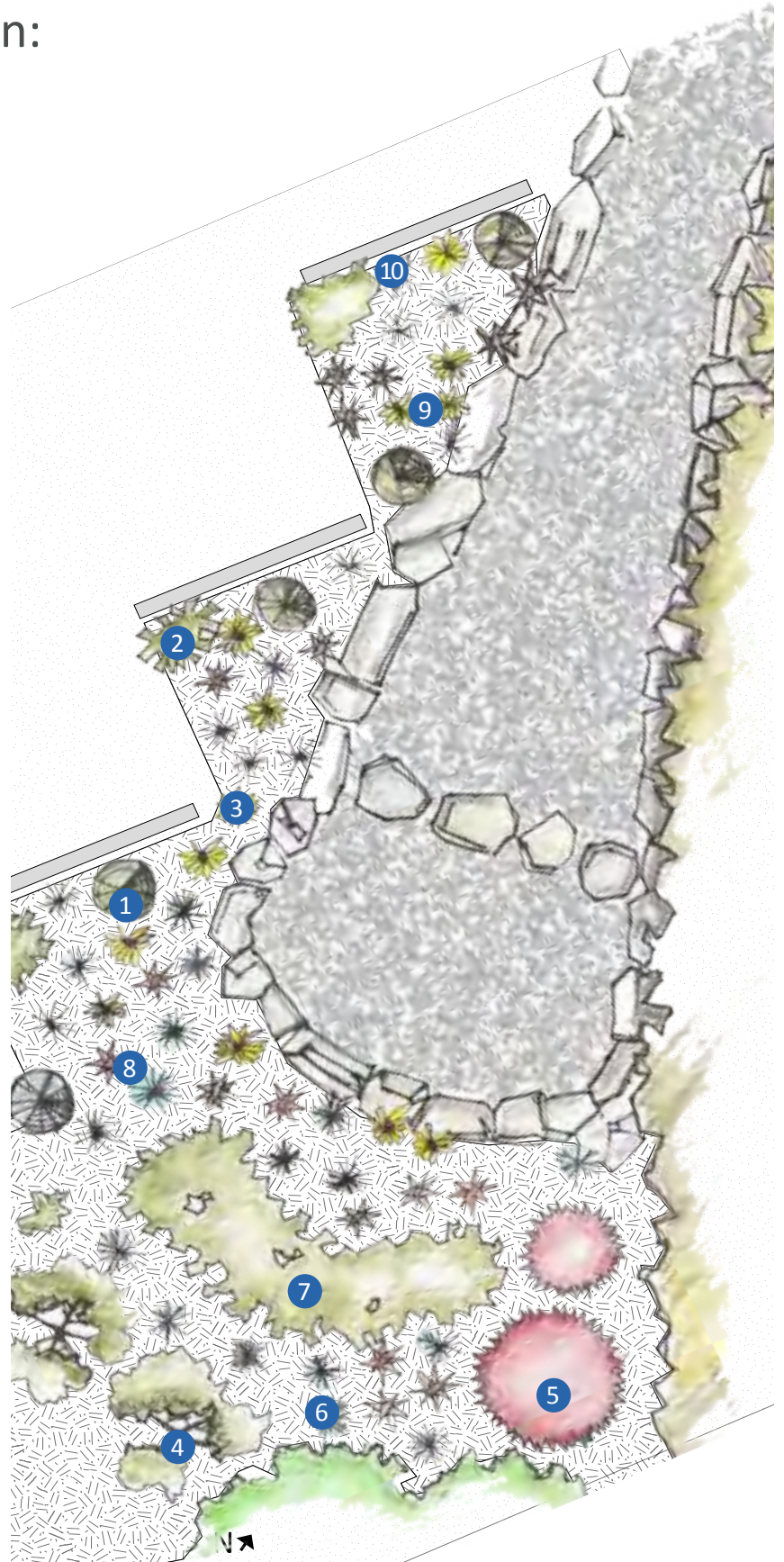

Figure 3: Summerland Rain Garden Planting Plan

## Plant List

SHRUBS	
1	<i>Amelanchier alnifolia</i> (Saskatoon)
2	<i>Arctostaphylos uva-ursi</i> (Kinnickinnick)
3	<i>Ericameria nauseosa</i> (Rabbitbrush)
4	<i>Juniperus scopulorum</i> (Rocky Mountain Juniper)
5	<i>Mahonia aquifolium</i> (Oregon Grape)
6	<i>Philadelphus lewisii</i> (Mock Orange)
7	<i>Cornus stolonifera</i> (Red Osier Dogwood)
PERENNIALS	
8	<i>Aquilegia formosa</i> (Western Crimson Columbine)
9	<i>Oenothera missouriensis</i> (Missouri Evening Primrose)
GRASSES	
10	<i>Festuca idahoensis</i> (Idaho Fescue)



Image 4: Dry creek bed was filled with gravel and large rocks were selectively positioned



Image 5: Native plants were planted by our volunteers on a rainy day in March 2014

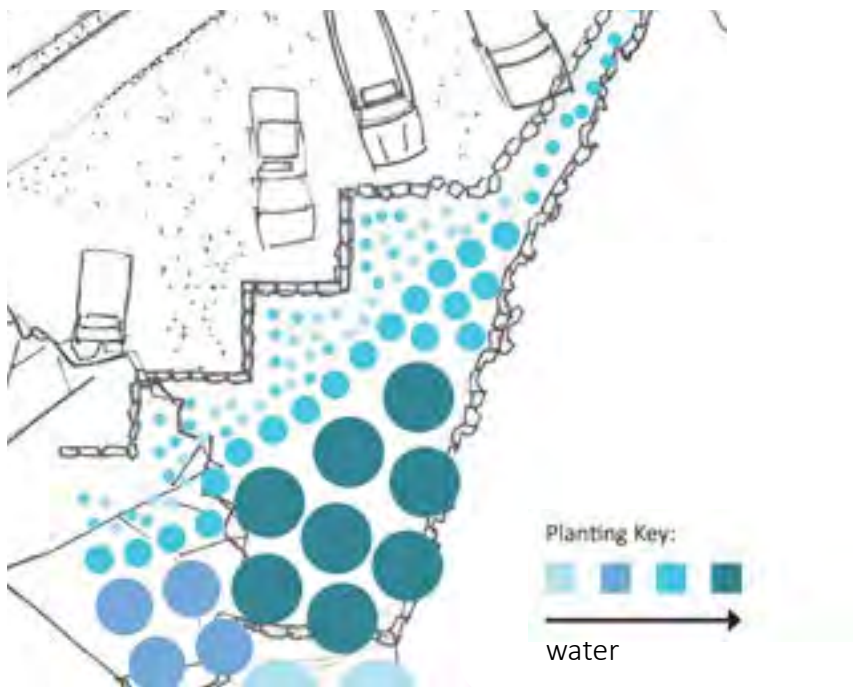

Figure 4: Diagram illustrating planting zones



Image 6: Regular garden tours for community and tourists

Typical Temperature Variations:

Summer HIGH: 38.5 C  
Winter LOW: -4.6 C

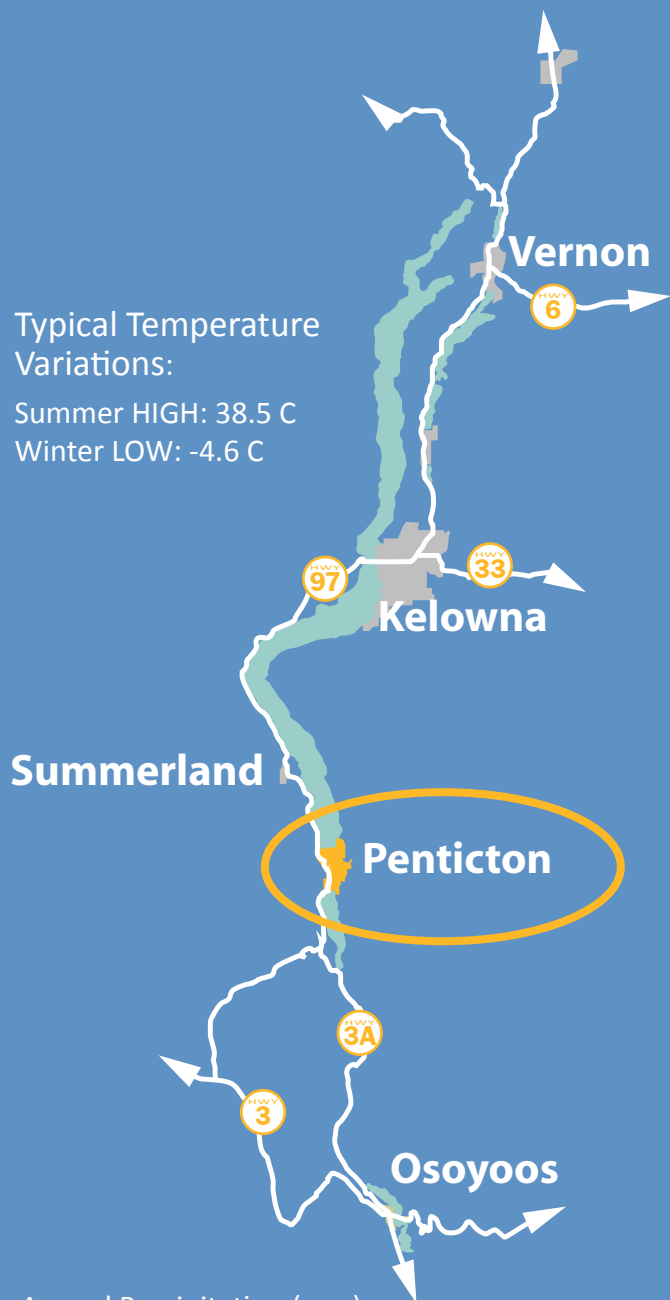

Annual Precipitation (mm)

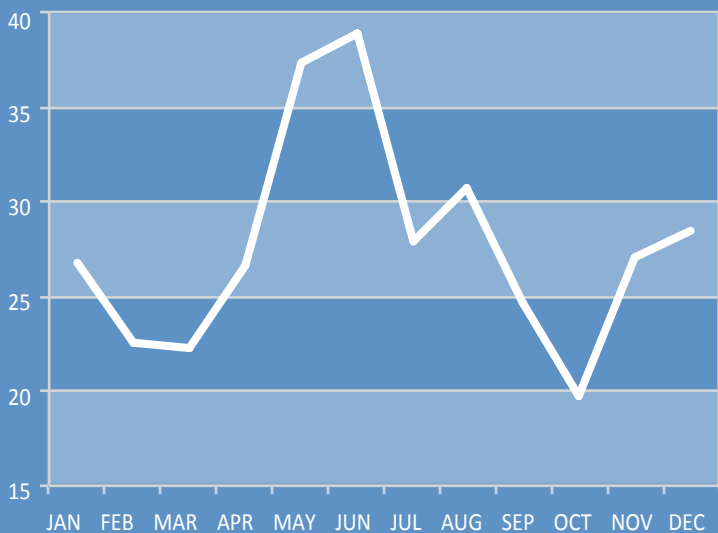

## Case Study #4

### PENTICTON: RDOS entrance garden

101 Martin Street  
Penticton, BC

The South Okanagan rain garden in the heart of Penticton was chosen for its central location, walk-by traffic, close proximity to the public beach at Okanagan Lake, and ease of access for the city and the regional district to use it as a teaching garden. Located at the regional district's main office, it is adjacent to a busy roadway and across from the well-used Gyro Park. The garden measures 56 m<sup>2</sup> (605 ft.<sup>2</sup>).

Each case study illustrates a different type of rain garden and this particular garden is fully-enclosed, which means it is called a retention pond, as there is no overflow to a storm drain. The existing garden was in a concrete enclosure so was designed with the ponding area excavated to withstand a "one-in-300-year" rain event and includes a wet/dry well to capture overflow in case of a catastrophic rain event.

Lindsay Bourque, a B.C. Society of Landscape Architects intern, coordinated the overall design of the garden, and carefully calculated the ponding size and depth for the required holding capacity. Lindsay and Eva Antonijevic, RPBio, addressed the aesthetics, choosing plant materials for four-season interest, durability, and detailed plant placement. They considered views from the offices looking out to the gardens, and how it would appear to passers-by as the garden matures.

The City of Penticton Operations Department removed the overgrown junipers and several feet of depleted soil (Images 1 and 2). The vegetation and soils were taken to the local landfill to be chipped and composted. City staff also dug out the ponding area and contoured it

**Historically**, the **KVR RAILWAY** ran a few feet away from this site and **over the years** lots of **debris** fell off the trains only to be **rediscovered** during excavation.

to specifications. While excavating, it was discovered that the substrate was very gravelly and had lots of construction debris, including rocks, pit run sand, asphalt pieces, and even bits of coal.

City crews also dug the well, using a Vacu-truck, which was very effective. It used recycled water as a lubricant to wet the soil under the suction mouth, and then vacuumed the slurry out. The well is 3.25 m (10.7 ft.) deep and ground water was struck at 2.25 m (7.5 ft.). The perforated casing is 30 cm (12 in.) wide and 3.5 m (11.5 ft.) deep (Image 3). The well water level averages .75 m (2.5 ft.) and provides the remaining space for overflow if required.

The soil 'perc' test confirmed the poor porous substrate. Water drained away as fast as it was poured into the hole. This was repeated many times with the same result, so it was decided to put a 7.5 cm (3 in.) layer of tamped Okanagan silt clay in the very bottom and halfway up the sides of the pond area (Image 4). This impedes the drainage and slows the water's flow down, providing time for it to filter through the clay, allowing the plants to take up water before it moves into the substrate. Added over top of the clay was a 1 cm layer of granite chips (Image 5). The chips mesh together to seal the clay under an impervious layer so the clay won't break up or degrade in contact with soils and people working in the area.

The well will irrigate the garden as it gets established. This irrigation system demonstrates how solar can be used to power the system. The single 150W solar panel charges a marine battery (water resistant). Power moves through a voltage inverter to an irrigation timer that controls the 12V standard demand water pump and the three zones of irrigation. Being close to the water table, it is expected that the plants (particularly the trees) will root down to



Image 1: Entrance garden overtaken by juniper



Image 2: Removal of all plant material



Image 3: Installing the well casing

# RDOS Rain Garden: Planting Plan

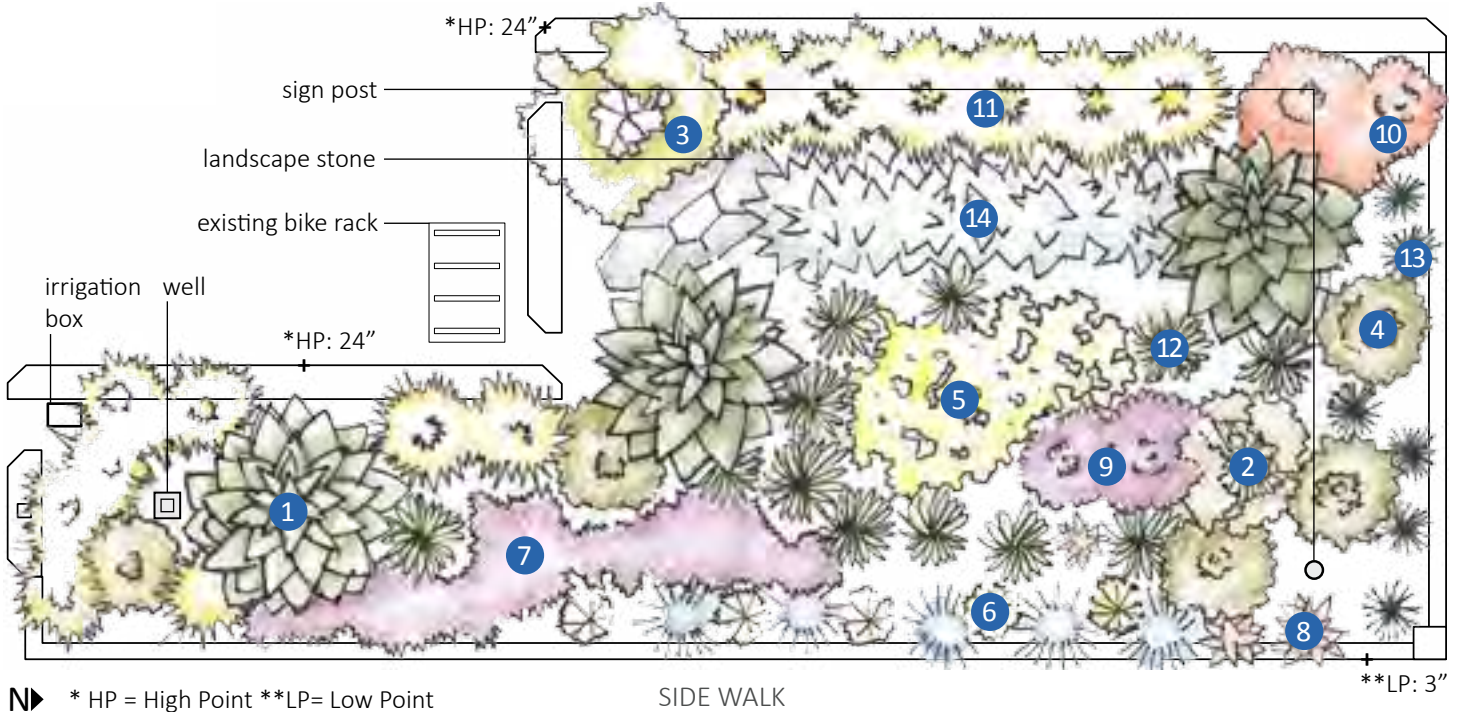

Figure 1: RDOS Rain Garden Planting Plan

the water table and require no supplemental water. The remainder of the garden is planted with very drought-tolerant plants anticipating that the irrigation will be a standby for extreme drought events.

Once the excavation and mitigation to the substrate was complete, the whole garden was refilled with a mixture of locally-produced compost from the city’s compost facility and organic topsoil. The organic topsoil is a mix of sand, peat and organic material (sifted, aged compost). Planting took two afternoons (eight hours), and a full eight-hour day for irrigation installation and system set-up. Lastly, the whole garden was top-dressed with 6 cm of mulch/compost (Image 6).

This installation is unique. Most property-owners would not have the equipment or the manpower to dig a well as deep as was dug for this demonstration garden. But, for those off-grid, or adventurous spirits, this is a technique to use non-treated water to irrigate, and it could be equally effective being used to pump from a buried cistern or water catchment system away from a formal garden. The solar power is also handy to add LED lights for Christmas or ambient lighting (Image 7).

Note: Costs are higher for this type garden at just over \$15/ft.<sup>2</sup>. In calculating square foot costs, in-kind hours and City/Regional staff were included at ‘union’ wage equivalents. All soil amendments were calculated at retail rates. A smaller garden using less expensive or free labour would be much less. The solar installation included the panel, battery, all connections, and cost \$1,200. It is very easy to add panels to this system, now that all the connection/distribution hardware is in place. Solar and irrigation system costs were added into the total costs per square foot.



# Plant List

## TREES

- 1 *Picea omorika* (Serbian Spruce)

## SHRUBS

- 2 *Ericameria nauseosa* (Rabbitbrush)
- 3 *Physocarpus opulifolius* 'Diablo' (Ninebark)
- 4 *Pinus mugo* (Mugo pine)

## PERENNIALS

- 5 *Oenothera missouriensis* (Missouri Evening Primrose)
- 6 *Penstemon fruticosus* (Shrubby Beardtongue)
- 7 *Coreopsis verticillata* (Threadleaf Tickseed)
- 8 *Eryngium spp.* (Sea Holly)
- 9 *Amsonia x 'Blue Eyes'* (Blue Star)
- 10 *Gaillardia* (Blanket Flower)

## GRASSES

- 11 *Calamagrostis x acutiflora* 'Karl Foerster' (Feather Reed Grass)
- 12 *Deschampsia cespitosa* 'Goldtau' (Tufted Hair Grass)
- 13 *Festuca idahoensis* (Idaho Fescue)
- 14 *Helictotrichon semipervirens* (Blue Oat Grass)



Image 4: Amending soil with clay barrier



Image 5: Irrigation ditch and drain rock







Image 7: Solar LED lighting



Image 6: After planting

# 5

## Okanagan RESOURCE LIST

Botanical Name	Common Name	Native	ZONE: Wet, Moist, Dry (W, M, D)
 <i>Shepherdia canadensis</i>	Scopulifolia	•	MW
 <i>Spiraea x Burholde Anthony Waterer</i>	Meadowsweet		MW
 <i>Symphoricarpos albus</i>	Snowberry	•	D
<b>Umbellales</b>			
 <i>Achillea millefolium</i>	Yarrow	•	M
 <i>Allium cernuum</i>	Nodding Onion		MD
 <i>Astragalus x tabernamontana Blue Jay</i>	Bluejay		D
 <i>Anaphalis</i> spp.	Pearly Everlasting		D
 <i>Aquilegia formosa</i>	Western Columbine	•	MD

This guide book is available for download at:

[http://www.rdosmaps.bc.ca/min\\_bylaws/PublicWorks/Water/RainGarden/RBCRainGardenGuideBook.pdf](http://www.rdosmaps.bc.ca/min_bylaws/PublicWorks/Water/RainGarden/RBCRainGardenGuideBook.pdf)

The [complete master plant list](#) that is referred to in this guidebook is not attached to printed copies of the guide. The master list is included with the web version of the Guide Book and as a separate download available at:

[www.rdosmaps.bc.ca/min\\_bylaws/PublicWorks/Water/RainGarden/CaptureMasterPlantList.pdf](http://www.rdosmaps.bc.ca/min_bylaws/PublicWorks/Water/RainGarden/CaptureMasterPlantList.pdf)



The [Okanagan Xeriscape Association](#) has compiled a comprehensive list of hundreds of hardy, drought tolerant trees, shrubs, and grasses, many of which are suitable for an Okanagan rain garden. The database is searchable by Latin or common name, plant characteristics and it features colour photos of each plant. [www.okanaganxeriscape.org/db/](http://www.okanaganxeriscape.org/db/)



The [Slow it Guide](#) is a practical guide to protect your property and the environment from the effects of rainwater runoff.

[www.okwaterwise.ca/pdf/HomeDrainageGuide\\_Okanagan.pdf](http://www.okwaterwise.ca/pdf/HomeDrainageGuide_Okanagan.pdf)



The [Okanagan Basin Water Board](#) created a Make Water Work educational campaign as well as a localized dry climate plant list:

[OkWaterwise.ca](http://OkWaterwise.ca)

[Make Water Work:](#)

[www.makewaterwork.ca](http://www.makewaterwork.ca)

[Plant list:](#)

[www.makewaterwork.ca/plants](http://www.makewaterwork.ca/plants)

# Okanagan-Similkameen Rain Garden Guide Book

Master Plant List Companion Guide



planting **semi-arid**

**OKANAGAN** soil filtration drought depth  
landscape PLANTS

climate **run-off rain water**

drainage storm **GARDEN** trees local













# Okanagan - Similkameen









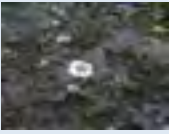

## Companion Master Plant List

	Botanical Name	Common Name	Native	ZONE: Wet, Moist, Dry (W, M, D)
TREES				
	<i>Picea omorika</i>	Serbian Spruce		D
	<i>Populus tremuloides</i>	Quaking Aspen	●	WM
	<i>Crataegus douglasii</i>	Black Hawthorn	●	MD
SHRUBS				
	<i>Amelanchier alnifolia</i>	Saskatoon	●	W
	<i>Arctostaphylos uva-ursi</i>	Kinnickinnick	●	D
	<i>Artemisia tridentata</i>	Big Basin Sagebrush	●	D
	<i>Caryopteris x clandonensis</i> 'Dark Night'	Blue Beard		D
	<i>Ceanothus sanguineus</i>	Red Stemmed Ceanothus	●	D
	<i>Ceanothus velutinus</i>	Snowbrush	●	D













	Botanical Name	Common Name	Native	ZONE: Wet, Moist, Dry (W, M, D)
	<i>Cornus stolonifera</i>	Red-osier Dogwood		WM
	<i>Elaeagnus commutata</i>	Wolf Willow		M
	<i>Ericameria nauseosa</i> (syn. <i>Chrysothamnus nauseosus</i> )	Rabbitbrush	●	D
	<i>Euonymus alatus</i> 'Compactus'	Burning Bush		D
	<i>Holodiscus discolor</i>	Ocean Spray	●	D
	<i>Juniperus scopulorum</i>	Rocky Mountain Juniper	●	D
	<i>Lavandula angustifolia</i>	English Lavender		D
	<i>Mahonia aquifolium</i>	Oregon Grape	●	D
	<i>Penstemon fruticosus</i>	Shrubby Penstemon	●	D
	<i>Perovskia atriplicifolia</i>	Russian Sage		DM
	<i>Philadelphus lewisii</i>	Mock Orange	●	D







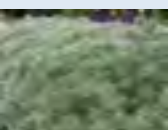

	Botanical Name	Common Name	Native	ZONE: Wet, Moist, Dry (W, M, D)
	<i>Physocarpus opulifolius</i> 'Diablo'	Ninebark	●	
	<i>Picea pungens</i> var <i>glauca</i> 'Baby Blue Eyes'	Dwarf Colorado Spruce		
	<i>Pinus mugo</i> var. <i>pumilo</i>	Dwarf Mountain Pine		D
	<i>Potentilla fruticosa</i> 'Goldfinger'	Cinquefoil	●	DM
	<i>Potentilla fruticosa</i>	Shrubby Cinquefoil	●	M
	<i>Purshia tridentata</i>	Antelope Brush	●	D
	<i>Ribes cereum</i>	Waxy Currant	●	DM
	<i>Rosa nutkana</i>	Nootka Rose	●	DM
	<i>Rosa woodsii</i>	Wood's Rose	●	DM
	<i>Salix exigua</i>	Sandbar Willow	●	MW
	<i>Sambucus caerulea</i>	Blue Elderberry	●	M







	Botanical Name	Common Name	Native	ZONE: Wet, Moist, Dry (W, M, D)
	<i>Shepherdia canadensis</i>	Soopalallie	●	MW
	<i>Spiraea x bumalda</i> 'Anthony Waterer'	Meadowsweet		MW
	<i>Symphoricarpos albus</i>	Snowberry	●	D
<b>PERENNIALS</b>				
	<i>Achillea millefolium</i>	Yarrow	●	M
	<i>Allium cernuum</i>	Nodding Onion		MD
	<i>Amsonia x tabernamontana</i> 'Blue Ice'	Bluestar		D
	<i>Anaphalis spp.</i>	Pearly Everlasting		D
	<i>Aquilegia formosa</i>	Western Columbine	●	MD
	<i>Arctostaphylos uva-ursi</i>	Kinnickinnick	●	DM
	<i>Artemisia schmidtiana</i> 'Nana'	Silver Mound		
	<i>Aster x frikartii</i> 'Monch'	Frikart's Aster		DM



	Botanical Name	Common Name	Native	ZONE: Wet, Moist, Dry (W, M, D)
	<i>Coreopsis verticillata</i> 'Zagreb'	Threadleaf Tickseed		D
	<i>Coreopsis</i> x 'Tequila Sunrise'	Variegated Tickseed		D
	<i>Echinacea purpurea</i>	Purple Coneflower		M
	<i>Eryngium</i> spp.	Sea Holly		D
	<i>Hemerocallis</i> spp.	Daylily	●	M
	<i>Heuchera cylindrica</i>	Round-leaved Alumroot	●	DM
	<i>Heuchera micrantha</i> 'Palace Purple'	Coral Bells		DM
	<i>Iris</i> spp.	Dwarf Bearded Iris		D
	<i>Liatris</i>	Gayfeather		D
	<i>Linum lewisii</i>	Blue Flax		D
	<i>Monarda didyma</i>	Beebalm		



	Botanical Name	Common Name	Native	ZONE: Wet, Moist, Dry (W, M, D)
	<i>Oenothera missouriensis</i>	Missouri Evening Primrose		D
	<i>Rudbeckia hirta</i>	Black Eyed Susan		M
	<i>Salvia nemorosa</i>	Perennial Salvia		M
	<i>Sedum alboroseum</i> 'Autumn Joy'	Stonecrop	●	DM
	<i>Sempervivum</i> spp.	Hens and Chicks		D
GRASSES				
	<i>Achnatherum hymenoides</i>	Indian Rice Grass	●	D
	<i>Bouteloua gracilis</i>	Blue Grama		D
	<i>Calamagrostis x acutiflora</i> 'Karl Foerster'	Feather Reed Grass		M
	<i>Calamagrostis x acutiflora</i> 'Overdam'	Variegated Reed grass		M
	<i>Deschampsia cespitosa</i> 'Goldtau'	Tufted Hair Grass		M
	<i>Elymus cinereus</i>	Great Basin Wild Rye	●	MW



	Botanical Name	Common Name	Native	ZONE: Wet, Moist, Dry (W, M, D)
	<i>Festuca arizonica</i>	Arizona Fescue		D
	<i>Festuca glauca</i> 'Elijah Blue'	Blue Fescue		D
	<i>Festuca idahoensis</i>	Idaho Fescue	●	D
	<i>Helictotrichon semipervirens</i>	Blue Oat Grass		D
	<i>Hesperostipa comata</i>	Needle and Thread Grass	●	D
	<i>Koeleria macrantha</i>	Junegrass	●	D
	<i>Panicum virgatum</i> 'Heavy Metal'	Switch Grass		DM
	<i>Pennisetum alopecuroides</i> 'Little Bunny'	Fountain Grass		D
	<i>Poa secunda</i>	Sandberg's Bluegrass	●	D
	<i>Pseudoroegneria spicata</i>	Bluebunch Wheatgrass	●	D
	<i>Schizachyrium scoparium</i>	Little Bluestem Grass		DM













# Okanagan









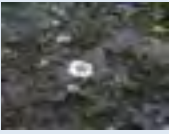

## Master Plant List

	Botanical Name	Common Name	Native	ZONE: Wet, Moist, Dry (W, M, D)
TREES				
	<i>Picea omorika</i>	Serbian Spruce		D
	<i>Populus tremuloides</i>	Quaking Aspen	●	WM
	<i>Crataegus douglasii</i>	Black Hawthorn	●	MD
SHRUBS				
	<i>Amelanchier alnifolia</i>	Saskatoon	●	W
	<i>Arctostaphylos uva-ursi</i>	Kinnickinnick	●	D
	<i>Artemisia tridentata</i>	Big Basin Sagebrush	●	D
	<i>Caryopteris x clandonensis</i> 'Dark Night'	Blue Beard		D
	<i>Ceanothus sanguineus</i>	Red Stemmed Ceanothus	●	D
	<i>Ceanothus velutinus</i>	Snowbrush	●	D













	Botanical Name	Common Name	Native	ZONE: Wet, Moist, Dry (W, M, D)
	<i>Cornus stolonifera</i>	Red-osier Dogwood		WM
	<i>Elaeagnus commutata</i>	Wolf Willow		M
	<i>Ericameria nauseosa</i> (syn. <i>Chrysothamnus nauseosus</i> )	Rabbitbrush	●	D
	<i>Euonymus alatus</i> 'Compactus'	Burning Bush		D
	<i>Holodiscus discolor</i>	Ocean Spray	●	D
	<i>Juniperus scopulorum</i>	Rocky Mountain Juniper	●	D
	<i>Lavandula angustifolia</i>	English Lavender		D
	<i>Mahonia aquifolium</i>	Oregon Grape	●	D
	<i>Penstemon fruticosus</i>	Shrubby Penstemon	●	D
	<i>Perovskia atriplicifolia</i>	Russian Sage		DM
	<i>Philadelphus lewisii</i>	Mock Orange	●	D







	Botanical Name	Common Name	Native	ZONE: Wet, Moist, Dry (W, M, D)
	<i>Physocarpus opulifolius</i> 'Diablo'	Ninebark	●	
	<i>Picea pungens</i> var <i>glauca</i> 'Baby Blue Eyes'	Dwarf Colorado Spruce		
	<i>Pinus mugo</i> var. <i>pumilo</i>	Dwarf Mountain Pine		D
	<i>Potentilla fruticosa</i> 'Goldfinger'	Cinquefoil	●	DM
	<i>Potentilla fruticosa</i>	Shrubby Cinquefoil	●	M
	<i>Purshia tridentata</i>	Antelope Brush	●	D
	<i>Ribes cereum</i>	Waxy Currant	●	DM
	<i>Rosa nutkana</i>	Nootka Rose	●	DM
	<i>Rosa woodsii</i>	Wood's Rose	●	DM
	<i>Salix exigua</i>	Sandbar Willow	●	MW
	<i>Sambucus caerulea</i>	Blue Elderberry	●	M



	Botanical Name	Common Name	Native	ZONE: Wet, Moist, Dry (W, M, D)
	<i>Shepherdia canadensis</i>	Soopalallie	●	MW
	<i>Spiraea x bumalda</i> 'Anthony Waterer'	Meadowsweet		MW
	<i>Symphoricarpos albus</i>	Snowberry	●	D
<b>PERENNIALS</b>				
	<i>Achillea millefolium</i>	Yarrow	●	M
	<i>Allium cernuum</i>	Nodding Onion		MD
	<i>Amsonia x tabernamontana</i> 'Blue Ice'	Bluestar		D
	<i>Anaphalis spp.</i>	Pearly Everlasting		D
	<i>Aquilegia formosa</i>	Western Columbine	●	MD
	<i>Arctostaphylos uva-ursi</i>	Kinnickinnick	●	DM
	<i>Artemisia schmidtiana</i> 'Nana'	Silver Mound		
	<i>Aster x frikartii</i> 'Monch'	Frikart's Aster		DM



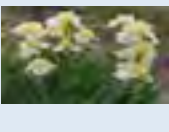

	Botanical Name	Common Name	Native	ZONE: Wet, Moist, Dry (W, M, D)
	<i>Coreopsis verticillata</i> 'Zagreb'	Threadleaf Tickseed		D
	<i>Coreopsis</i> x 'Tequila Sunrise'	Variegated Tickseed		D
	<i>Echinacea purpurea</i>	Purple Coneflower		M
	<i>Eryngium</i> spp.	Sea Holly		D
	<i>Hemerocallis</i> spp.	Daylily	●	M
	<i>Heuchera cylindrica</i>	Round-leaved Alumroot	●	DM
	<i>Heuchera micrantha</i> 'Palace Purple'	Coral Bells		DM
	<i>Iris</i> spp.	Dwarf Bearded Iris		D
	<i>Liatris</i>	Gayfeather		D
	<i>Linum lewisii</i>	Blue Flax		D
	<i>Monarda didyma</i>	Beebalm		



	Botanical Name	Common Name	Native	ZONE: Wet, Moist, Dry (W, M, D)
	<i>Oenothera missouriensis</i>	Missouri Evening Primrose		D
	<i>Rudbeckia hirta</i>	Black Eyed Susan		M
	<i>Salvia nemorosa</i>	Perennial Salvia		M
	<i>Sedum alboroseum</i> 'Autumn Joy'	Stonecrop	●	DM
	<i>Sempervivum</i> spp.	Hens and Chicks		D
GRASSES				
	<i>Achnatherum hymenoides</i>	Indian Rice Grass	●	D
	<i>Bouteloua gracilis</i>	Blue Grama		D
	<i>Calamagrostis x acutiflora</i> 'Karl Foerster'	Feather Reed Grass		M
	<i>Calamagrostis x acutiflora</i> 'Overdam'	Variegated Reed grass		M
	<i>Deschampsia cespitosa</i> 'Goldtau'	Tufted Hair Grass		M
	<i>Elymus cinereus</i>	Great Basin Wild Rye	●	MW



	Botanical Name	Common Name	Native	ZONE: Wet, Moist, Dry (W, M, D)
	<i>Festuca arizonica</i>	Arizona Fescue		D
	<i>Festuca glauca</i> 'Elijah Blue'	Blue Fescue		D
	<i>Festuca idahoensis</i>	Idaho Fescue	●	D
	<i>Helictotrichon semipervirens</i>	Blue Oat Grass		D
	<i>Hesperostipa comata</i>	Needle and Thread Grass	●	D
	<i>Koeleria macrantha</i>	Junegrass	●	D
	<i>Panicum virgatum</i> 'Heavy Metal'	Switch Grass		DM
	<i>Pennisetum alopecuroides</i> 'Little Bunny'	Fountain Grass		D
	<i>Poa secunda</i>	Sandberg's Bluegrass	●	D
	<i>Pseudoroegneria spicata</i>	Bluebunch Wheatgrass	●	D
	<i>Schizachyrium scoparium</i>	Little Bluestem Grass		DM







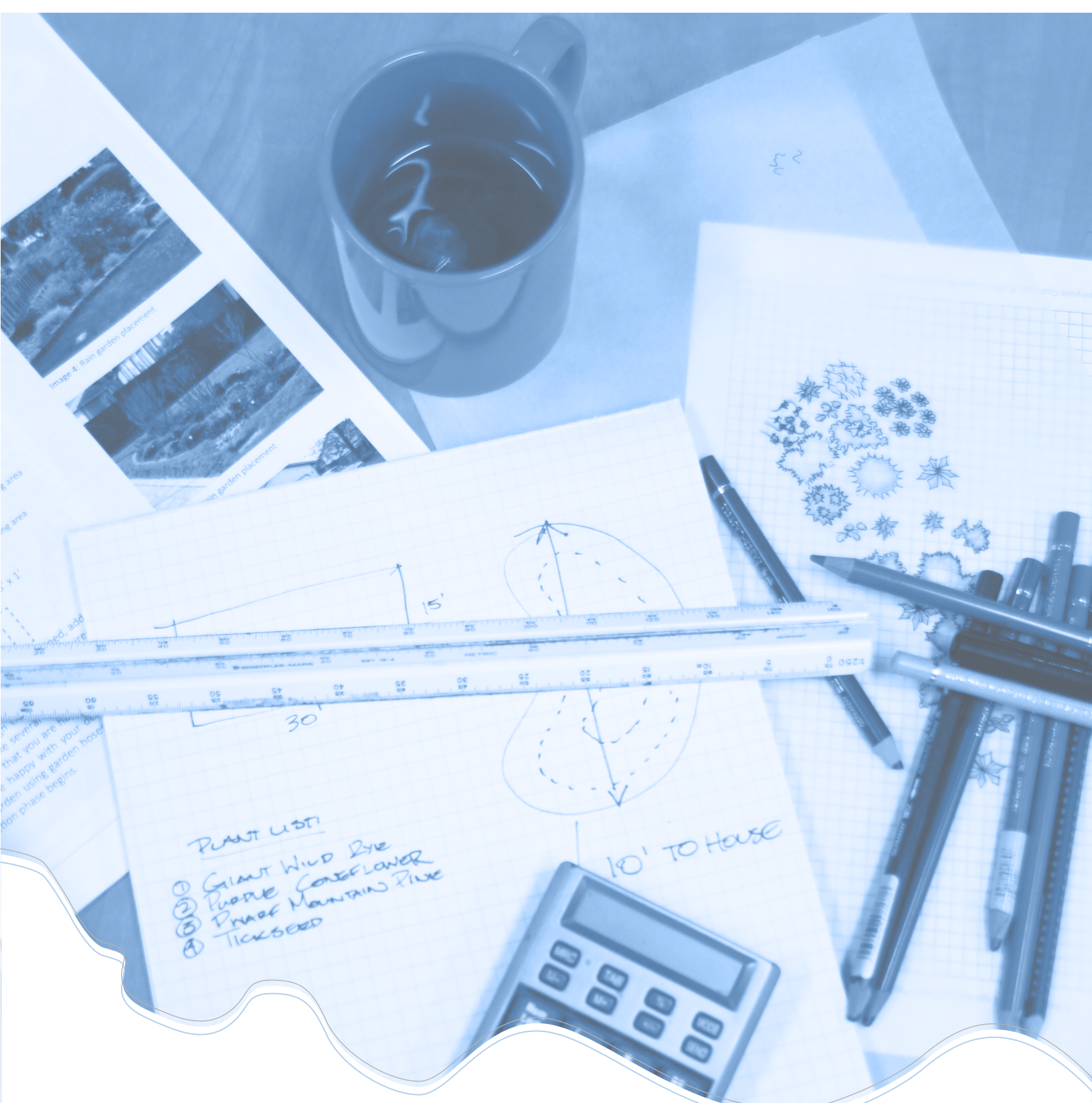

Funding Provided By:



**RBC**  
**Blue Water**  
**Project™**

This manual is designed for free distribution, with no copyright; credits required when using this material.  
Copies can be obtained from:

Regional District of Okanagan-Similkameen | 101 Martin Street | Penticton, BC | V2A 5J9 | [www.rdos.bc.ca](http://www.rdos.bc.ca)  
2016